

# DRENAJE PUNTUTAL DE PLÁSTICO

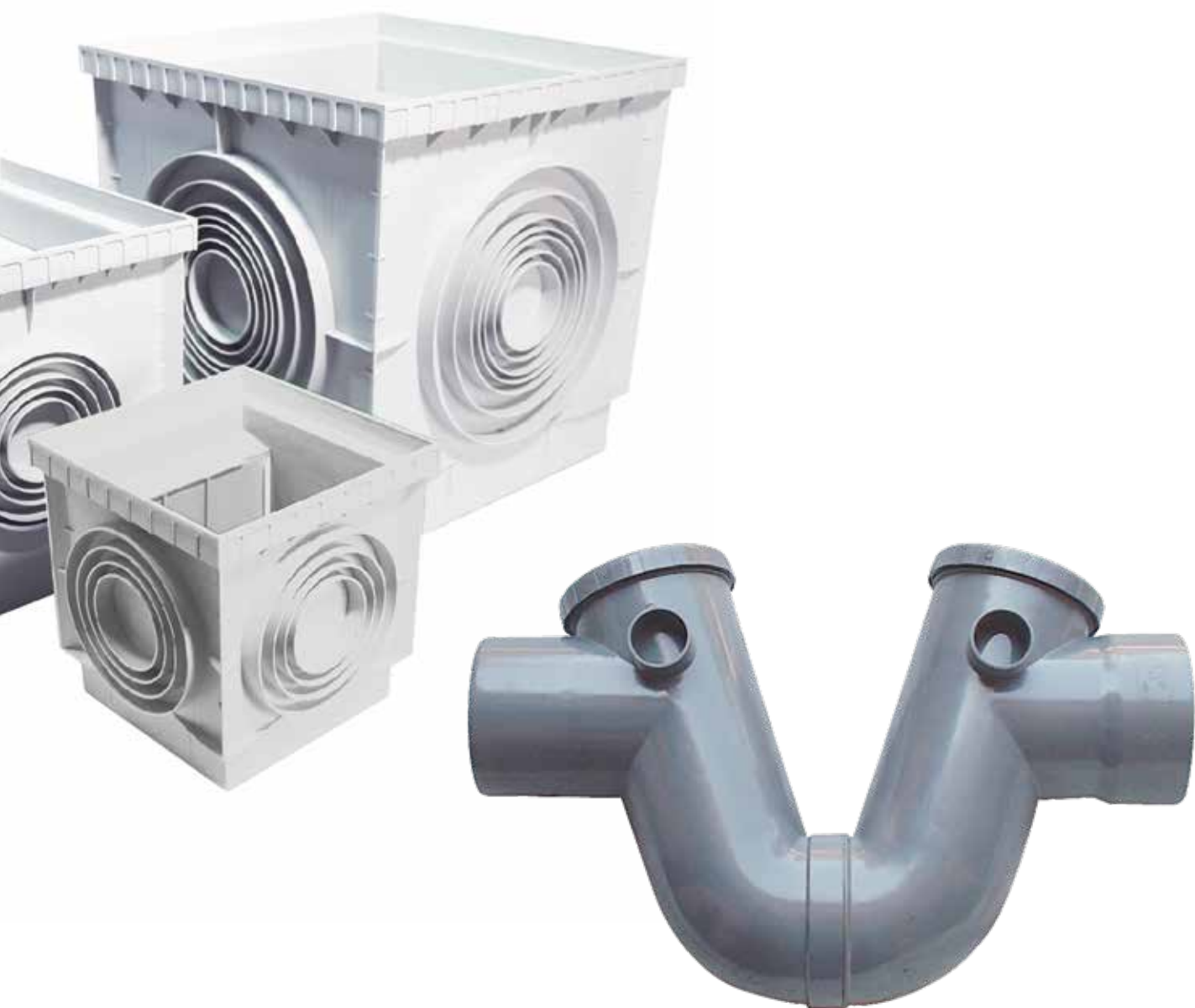

# DRENAJE PUNTUAL DE PLÁSTICO



# ÍNDICE



**ARQUETA DE  
POLIPROPILENO Y  
COMPLEMENTOS** 120



**ARQUETA PARA  
CABLES ELÉCTRICOS** 124



**TAPAS, REJILLAS  
Y MARCOS DE  
POLIPROPILENO** 121



**ARQUETA PLUVIAL** 124



**TAPAS DE FUNDICIÓN  
PARA ARQUETA** 122



**SUMIDEROS SIFÓNICOS  
DE POLIPROPILENO  
Y PVC** 125



**TAPAS CON SUMIDERO  
Y MARCO** 122



**CAZOLETAS** 127



**TAPA RELLENABLE  
Y MARCO** 122



**PUERTA CONTADOR  
DE ABS** 128



**TAPAS HERMÉTICAS** 123



**SIFÓN EN  
LINEA DE PVC** 128

# DRENAJE PUNTUAL DE PLÁSTICO

## ARQUETA DE POLIPROPILENO

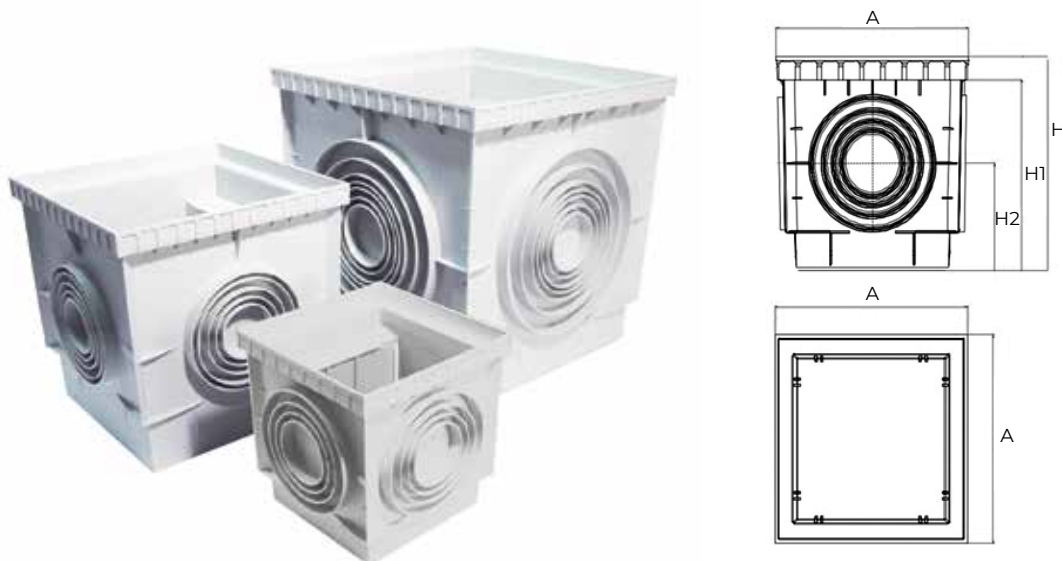

CÓDIGO	Tamaño	A	H	H1	H2	Ø Entradas/Salidas	Ud. Embalaje	PVP €/ud.
ARQ20S	200 x 200	196	200	180	100	50 - 63 - 80 - 100 - 125	12	5,29
ARQ30S	300 x 300	292	295	273	147	63 - 80 - 100 - 125 - 140	12	11,87
ARQ40S	400 x 400	394	394	368	196	80 - 100 - 125 - 140 - 160 - 200 - 250	12	24,43
ARQ55S	550 x 550	545	520	484	266	160 - 200 - 250 - 315	12	57,91

## PLACA SIFÓNICA PARA ARQUETA DE POLIPROPILENO



CÓDIGO	Tamaño	A	B	C	H	Ud. Embalaje	PVP €/ud.
PS20S	200 x 200	156	166	123	26	12	3,17
PS30S	300 x 300	248	252	191	47	12	3,96
PS40S	400 x 400	345	350	-	52,5	12	5,84
PS55S	550 x 550	485	335	-	85	12	12,58

# DRENAJE PUNTUAL DE PLÁSTICO

## TAPAS, REJILLAS Y MARCOS DE POLIPROPILENO

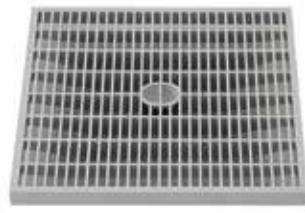

### TAPA

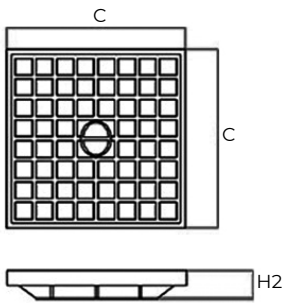

CÓDIGO	Tamaño	A	H	Ud. Embalaje	PVP €/ud.
TAPA20S	200 x 200	185	25	12	2,63
TAPA30S	300 x 300	280	28	12	5,86
TAPA40S	400 x 400	380	33	12	13,43
TAPA55S *	550 x 550	530	56	12	43,34

\*La tapa de 550 x 550 mm dispone de un perno central para facilitar su apertura.

### REJILLA

CÓDIGO	Tamaño	A	H	Ud. Embalaje	PVP €/ud.
REJA20S	200 x 200	185	25	12	2,67
REJA30S	300 x 300	280	28	12	6,11
REJA40S	400 x 400	380	33	12	13,43
REJA55S *	550 x 550	530	56	12	43,04

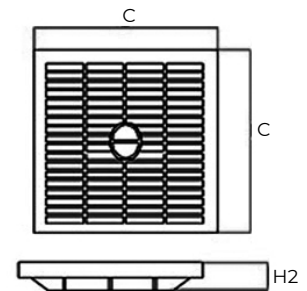

\*La rejilla de 550 x 550 mm dispone de un perno central para facilitar su apertura.

### MARCO PARA TAPA Y REJILLA

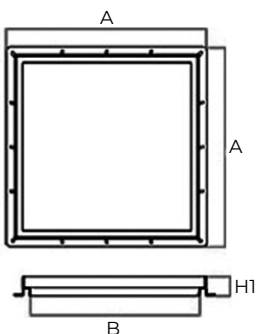

CÓDIGO	Tamaño	A	B	H	Ud. Embalaje	PVP €/ud.
MARCO20S	200 x 200	212	165	39	12	1,89
MARCO30S	300 x 300	325	252	40	12	3,53
MARCO40S	400 x 400	427	386	42	12	5,45
MARCO55S	550 x 550	584	543	52	12	10,06

# DRENAJE PUNTUAL DE PLÁSTICO

## TAPA DE FUNDICIÓN PARA ARQUETA DE POLIPROPILENO

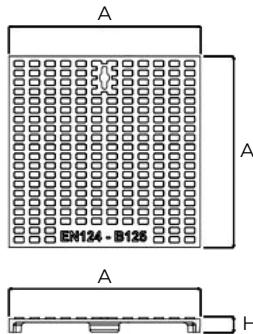

CÓDIGO	Tamaño	A	H	Clase de carga	Ud. Embalaje	PVP €/ud.
TF20KB	200 x 200	185	19	B125	12	22,09
TF30KB	300 x 300	280	20	B125	12	44,46
TF40KB	400 x 400	380	27	B125	12	77,85
TF55KB	550 x 550	530	36	B125	12	159,87

## TAPA CON SUMIDERO Y MARCO

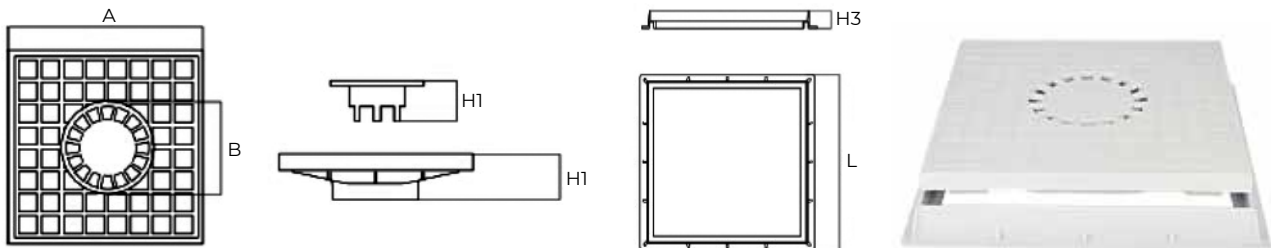

CÓDIGO	Tamaño	A	B	L	H1	H2	H3	Ud. Embalaje	PVP €/ud.
TAPA30SS	300 x 300	280	135	315	55	60	40	12	11,19
TAPA40SS	400 x 400	380	175	435	76	85	45	12	21,53

## TAPA RELLENABLE Y MARCO

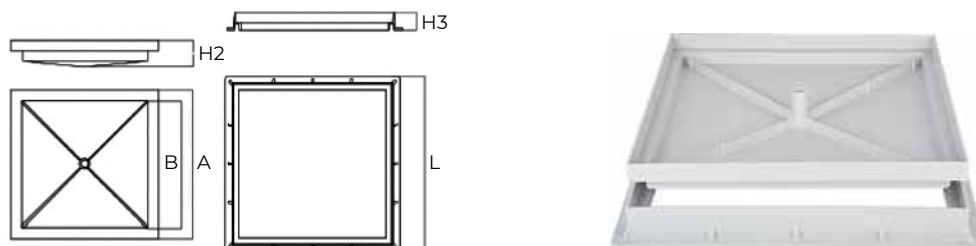

CÓDIGO	Tamaño	A	B	L	H2	H3	Ud. Embalaje	PVP €/ud.
T130S	300 x 300	285	24	315	55	40	12	10,82
T140S	400 x 400	385	36	435	55	45	12	15,95

# DRENAJE PUNTUAL DE PLÁSTICO

## TAPA HERMÉTICA CON TORNILLOS, JUNTA DE CAUCHO Y MARCO

Tapa hermética y marco, ambos fabricados en ABS, con junta de goma y 4 tornillos.

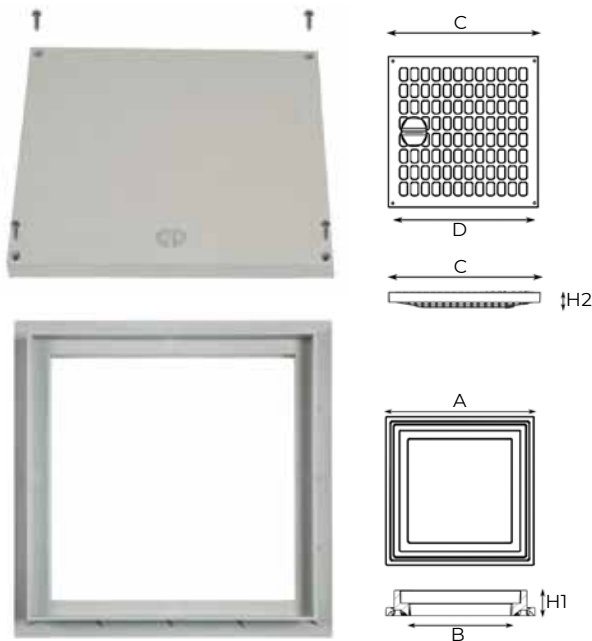

Tamaño	A	B	H1	C	D	H2
200 x 200	232	160	38	185	167	29
300 x 300	330	250	41	280	272	38
400 x 400	439	345	44	380	362	42
550 x 550	603	476	67	530	507	49

CÓDIGO	Tamaño	Descripción	Ud. Embalaje	PVP €/ud.
TAPA20SH	200 x 200	Tapa hermética + junta + tornillos + marco 200	12	13,38
TAPA30SH	300 x 300	Tapa hermética + junta + tornillos + marco 300	12	20,56
TAPA40SH	400 x 400	Tapa hermética + junta + tornillos + marco 400	12	34,25
TAPA55SH	550 x 550	Tapa hermética + junta + tornillos + marco 550	12	85,21

## TAPA HERMÉTICA CON TORNILLOS, JUNTA DE CAUCHO Y ARQUETA

Tapa hermética de ABS, con junta de goma, 4 tornillos y arqueta de polipropileno.



CÓDIGO	Tamaño	Descripción	Ud. Embalaje	PVP €/ud.
ARQ20SH	200 x 200	Tapa hermética + junta + tornillos + arqueta 200	12	17,89
ARQ30SH	300 x 300	Tapa hermética + junta + tornillos + arqueta 300	12	30,70
ARQ40SH	400 x 400	Tapa hermética + junta + tornillos + arqueta 400	12	56,73
ARQ55SH	550 x 550	Tapa hermética + junta + tornillos + arqueta 550	12	137,51

# DRENAJE PUNTUAL DE PLÁSTICO

## ARQUETA DE POLIPROPILENO PARA CABLES ELÉCTRICOS

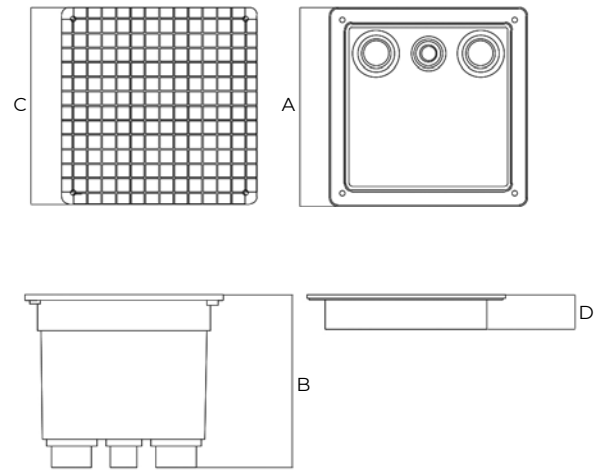

CÓDIGO	Tamaño	A	B	C	D	Ud. Embalaje	PVP €/ud.
ARQ25PPE	250 x 250	275	240	271	48	12	18,39

## ARQUETA PLUVIAL DE POLIPROPILENO



Ø 80 - 100  
Ø 90 - 110  
Ø 110 - 125



80 - 100

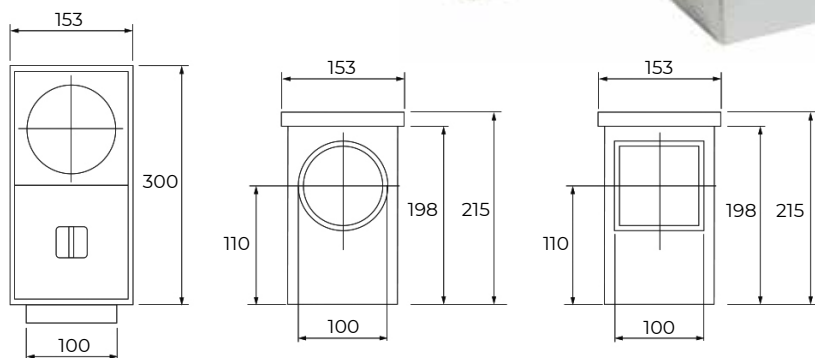

CÓDIGO	Entrada de tubo	Salida de tubo	Ud. Embalaje	PVP €/ud.
APS080100	Ø 80 - 100	Ø 100	12	12,20
APS090110	Ø 90 - 110	Ø 100	12	12,20
APS110125	Ø 110 - 125	Ø 100	12	12,20
APSQ80100	Ø 80 - 100	Ø 100	12	12,20
APSRACOR	Ø 100	Ø 100	12	2,15



# DRENAJE PUNTUAL DE PLÁSTICO

## SUMIDERO SIFÓNICO DE POLIPROPILENO SALIDA VERTICAL



CÓDIGO	Tamaño	A	B	C	H	Desagüe	Ud. Embalaje	PVP €/ud.
SSV10PP	100 x 100	100	90	80	46	Ø 32 - 40	48	1,23
SSV15PP	150 x 150	150	135	125	58	Ø 40 - 50 - 63	32	2,55
SSV20PP	200 x 200	200	180	150	75	Ø 80 - 100 - 110	28	5,44
SSV25PP	250 x 250	250	190	190	82	Ø 100 - 110	24	6,58
SSV30PP	300 x 300	300	220	220	100	Ø 100 - 110 - 125	30	10,10

## SUMIDERO SIFÓNICO DE PVC CON SALIDA VERTICAL/HORIZONTAL Y EMBELLECEDOR DE ACERO INOXIDABLE

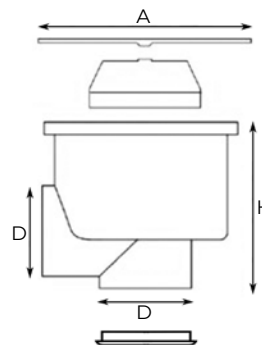

CÓDIGO	Medidas	Ø Salida	A	D	H	Ud. Embalaje	PVP €/ud.
SSEIPVC	115 x 115	Ø 40/50	115	50	98	27	8,39

# DRENAJE PUNTUAL DE PLÁSTICO

## SUMIDERO SIFÓNICO DE POLIPROPILENO CON SALIDA HORIZONTAL

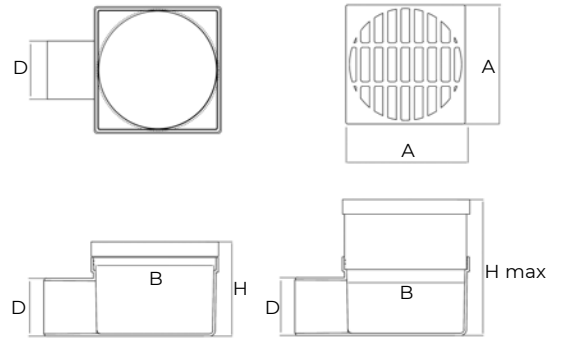

## SUMIDERO CON REJILLA DE PLÁSTICO

CÓDIGO	Tamaño	A	B	D	H	Desagüe	Ud. Embalaje	PVP €/ud.
SSH10PP	115 x 115	110	106	50	71	Ø 50	40	3,81
SSH15PP	150 x 150	150	146	50	71	Ø 50	48	5,05
SSH20PP	200 x 200	200	168	50	72	Ø 50	25	11,63
SSH25PP	250 x 250	250	212	63	90	Ø 63	12	19,07
SSH30PP	300 x 300	300	259	80	110	Ø 80	8	28,95

## SUMIDERO TELESCÓPICO CON REJILLA DE PLÁSTICO

CÓDIGO	Tamaño	A	B	D	H (min. y max.)	Desagüe	Ud. Embalaje	PVP €/ud.
SSH10PPT	115 x 115	110	106	50	71 - 110	Ø 50	24	5,46
SSH15PPT	150 x 150	150	146	50	71 - 110	Ø 50	28	6,84

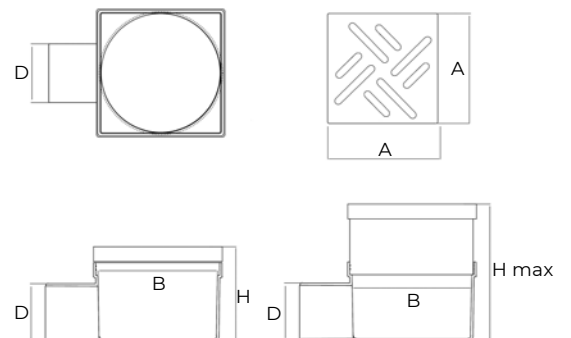

## SUMIDERO CON REJILLA DE ACERO INOXIDABLE

CÓDIGO	Tamaño	A	B	D	H	Desagüe	Ud. Embalaje	PVP €/ud.
SSH10PPI	115 x 115	110	106	50	71	Ø 50	40	7,64
SSH15PPI	150 x 150	150	146	50	71	Ø 50	48	11,14

## SUMIDERO TELESCÓPICO CON REJILLA DE ACERO INOXIDABLE

CÓDIGO	Tamaño	A	B	D	H (min. y max.)	Desagüe	Ud. Embalaje	PVP €/ud.
SSH10PPIT	115 x 115	110	106	50	71 - 110	Ø 50	24	8,63
SSH15PPIT	150 x 150	150	146	50	71 - 110	Ø 50	28	12,25

# DRENAJE PUNTUAL DE PLÁSTICO

## CAZOLETAS DE PVC



### CAZOLETA VERTICAL/HORIZONTAL

CÓDIGO	Rejilla	Ø Salida	H1	H2	A	B	Ud. Emb.	PVP €/ud.
CZL050VH	100 x 100	Ø 50/40	50	90	110	160	6	11,27

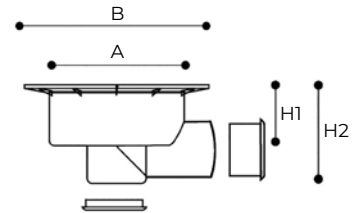

### CAZOLETA VERTICAL

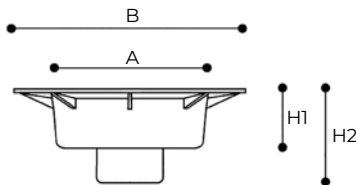

CÓDIGO	Rejilla	Ø Salida	H1	H2	A	B	Ud. Emb.	PVP €/ud.
CZL075V	150 x 150	Ø 75	65	122	140	220	6	7,14
CZL090V	200 x 200	Ø 90	80	135	180	290	6	13,31
CZL110V	250 x 250	Ø 110	80	145	220	350	6	13,79

### CAZOLETA HORIZONTAL

CÓDIGO	Rejilla	Ø Salida	H1	H2	A	B	Ud. Emb.	PVP €/ud.
CZL075H	150 x 150	Ø 75	65	110	140	220	6	8,17
CZL090H	200 x 200	Ø 90	80	135	180	290	6	13,79
CZL110H	250 x 250	Ø 110	80	145	220	350	6	16,37

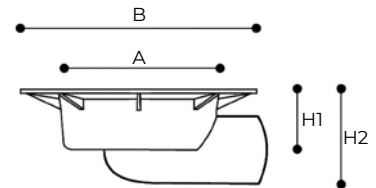

### CAZOLETA, SUMIDERO SIFÓNICO DE PVC Y PARAHOJAS



CÓDIGO	Tamaño	Descripción	Ud. Emb.	PVP €/ud.
CZPH090V	200 x 200 Vertical	Cazoleta con sumidero y parahojas de 200x200. Salida vertical Ø 90 mm y altura 180 mm	6	40,25
CZPH110V	250 x 250 Vertical	Cazoleta con sumidero y parahojas de 250x250. Salida vertical Ø 90 - 110 mm y altura 240 mm	6	42,17
CZPH090H	200 x 200 Horizontal	Cazoleta con sumidero y parahojas de 200x200. Salida horizontal Ø 90 mm y altura 180 mm	6	40,74
CZPH110H	250 x 250 Horizontal	Cazoleta con sumidero y parahojas de 250x250. Salida horizontal Ø 110 mm y altura 240 mm	6	44,75

### SUMIDERO SIFÓNICO DE PVC Y PARAHOJAS



CÓDIGO	Tamaño	Descripción	Ud. Emb.	PVP €/ud.
SSV20PH	200 x 200	Sumidero de 200 x 200 con parahojas salida Ø 90 mm y altura 85 mm	6	28,58
SSV25PH	250 x 250	Sumidero de 250 x 250 con parahojas salida Ø 90 - 110 mm y altura 85 mm	6	30,09

# DRENAJE PUNTUAL DE PLÁSTICO

## PUERTA CONTADOR DE ABS

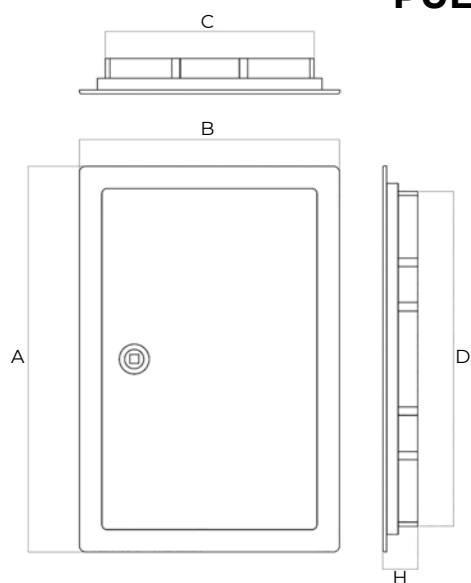

CÓDIGO	A	B	C	D	H	Ud. Embalaje	PVP €/ud.
PC2030	310	210	270	100	30	12	15,19
PC3040	460	310	420	200	30	12	20,01
PC4050	500	400	460	360	30	12	33,91
PC6040	600	400	560	360	30	12	38,20

## SIFÓN EN LÍNEA DE PVC CON TAPAS DE REGISTRO

Sifón en línea con 2 tapas de registro.



CÓDIGO	Ø Salida	Tipo de unión	Ud. Embalaje	PVP €/ud.
SL075M	Ø 75	Encolado	6	46,17
SL090M	Ø 90	Encolado	6	65,25
SL110	Ø 110	Encolado	6	42,18
SL125	Ø 125	Encolado	6	45,04
SL160	Ø 160	Encolado	6	65,62
SL200	Ø 200	Encolado	6	120,95

**NOVEDAD**