

ACCESORIOS DE IMPERMEABILIZACIÓN

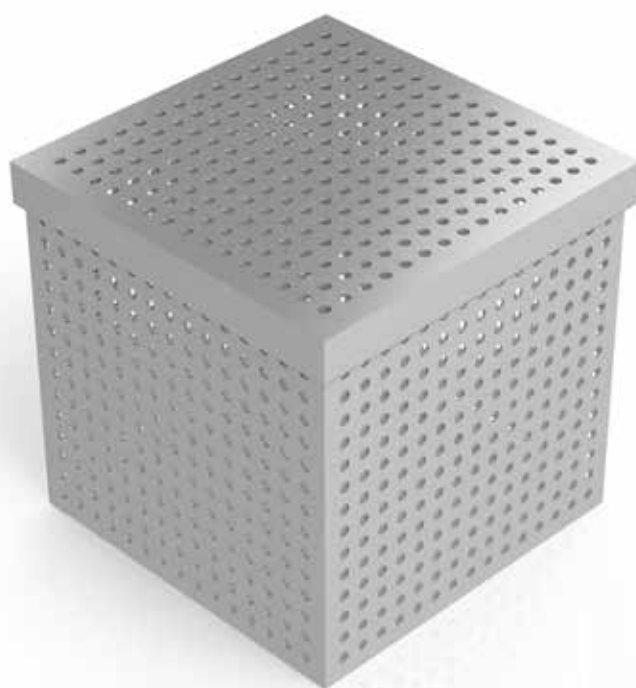

ACCESORIOS DE IMPERMEABILIZACIÓN



ÍNDICE



DESAGÜES FLEXIBLES Y ACCESORIOS DE EPDM

Láminas asfálticas y de EPDM **150**



PARAHOJAS Y PARAGRAVAS

160



DESAGÜES Y ACCESORIOS DE TPE

Láminas asfálticas y de EPDM **152**



PEINE ANTINIDOS Y PROTECTOR DE AVES

162



DESAGÜES Y ACCESORIOS DE PVC

Láminas de PVC **157**



CAZOLETAS DE PVC

163



DESAGÜES Y ACCESORIOS DE TPO

Láminas de TPO **158**



SISTEMAS DE FIJACIÓN LÁMINAS Y AISLAMIENTO

Pletinas, perfiles y clavo-tacos **164**

ACCESORIOS DE IMPERMEABILIZACIÓN DESAGÜES Y ACCESORIOS DE EPDM

DESAGÜE FLEXIBLE DE EPDM

Desagüe flexible y elástico de caucho EPDM vulcanizado, para láminas asfálticas elastoméricas y plastoméricas, H=200 mm.

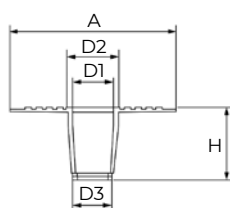
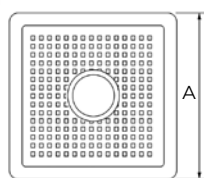

CÓDIGO	Ø	A	D1	D2	D3	H	Ud. Embalaje	PVP €/ud.
DV040EPDM	40	250	33	39	31	175	25	17,15
DV050EPDM	50	310	45	50	42	200	25	20,00
DV060EPDM	60	305	51	57	49	200	25	20,70
DV075EPDM	75	340	66	72	63	200	25	24,12
DV080EPDM	80	330	74	80	70	200	25	19,40
DV090EPDM	90	330	80	86	78	200	25	21,94
DV100EPDM	100	340	93	99	87	200	25	20,14
DV110EPDM	110	340	99	105	94	200	25	23,43
DV120EPDM	120	340	113	119	107	200	25	23,99
DV125EPDM	125	370	116	122	113	200	20	25,55
DV140EPDM	140	370	132	138	124	200	20	28,67
DV150EPDM	150	390	140	146	132	200	15	30,10
DV160EPDM	160	360	150	156	146	200	15	34,09
DV200EPDM	200	440	189	195	179	210	10	45,22

PARAHOJAS DE POLIPROPILENO PARA DESAGÜE FLEXIBLE

Parahojas de polipropileno para desagüe flexible y elástico de caucho EPDM vulcanizado.

CÓDIGO	Ø	A	B	H	Ud. Embalaje	PVP €/ud.
PHD060PP	50-60	47	54	84	25	2,68
PHD075PP	75	62	75	105	25	2,72
PHD080PP	80	68	70	100	25	2,77
PHD090PP	90	78	70	100	25	2,83
PHD100PP	100	88	70	100	25	2,87
PHD110PP	110	92	70	100	25	2,92
PHD120PP	120	100	70	100	25	3,06
PHD125PP	125	109	70	100	20	3,10
PHD140PP	140	125	70	100	20	3,14
PHD150PP	150	130	70	100	15	3,27
PHD160PP	160	143	75	105	15	3,82
PHD200PP	200	177	75	105	10	5,58

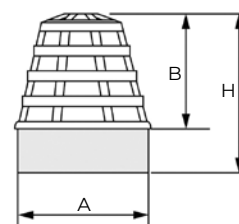

ACCESORIOS DE IMPERMEABILIZACIÓN DESAGÜES Y ACCESORIOS DE EPDM

DESAGÜE FLEXIBLE DE EPDM SIFONADO Y CON PARAHOJAS

Desagüe flexible y elástico de caucho EPDM vulcanizado, para láminas asfálticas elastoméricas y plastoméricas, sifonado y con parahoja.

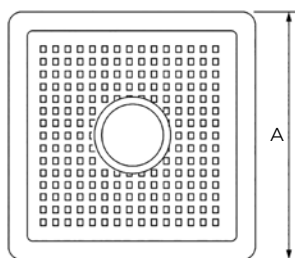
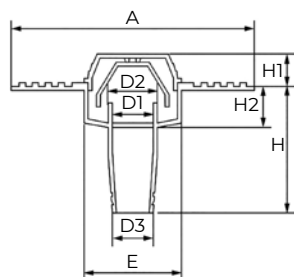

CÓDIGO	Ø	A	D1	D2	D3	E	H	H2	Ud. Embalaje	PVP €/ud.
DVS080EPDM	80	393	90	97	68	170	205	55	5	33,59
DVS090EPDM	90	363	93	100	78	170	205	55	5	34,28
DVS100EPDM	100	393	90	100	87	170	205	55	5	35,65
DVS110EPDM	110	363	100	107	94	170	205	55	5	36,10



ACCESORIOS DE IMPERMEABILIZACIÓN DESAGÜES Y ACCESORIOS DE TPE

DESAGÜE VERTICAL DE TPE

Desagüe vertical de TPE para láminas asfálticas y de caucho EPDM.

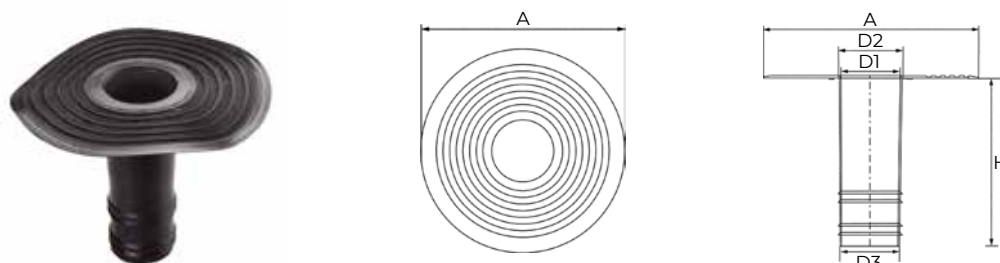

CÓDIGO	Para tubo	A	D1	D2	D3	H	Ud. Embalaje	PVP €/ud.
DV063TPE	Ø 63	320	51	60	49	250	25	12,14
DV075TPE	Ø 75	320	63	70	62	250	25	12,19
DV082TPE	Ø 82	320	69	75	68	250	25	12,54
DV090TPE	Ø 90	320	80	84	79	250	25	12,97
DV100TPE	Ø 100	320	86	90	85	250	25	13,63
DV110TPE	Ø 110	380	95	101	94	250	15	14,20
DV125TPE	Ø 125	380	109	115	108	250	15	15,39
DV140TPE	Ø 140	380	128	134	127	250	10	17,22
DV150TPE	Ø 150	380	134	140	132	250	10	19,25
DV160TPE	Ø 160	380	140	146	139	250	10	19,59

DESAGÜE HORIZONTAL TUBO REDONDO DE TPE

Desagüe de TPE para láminas asfálticas y de caucho EPDM.

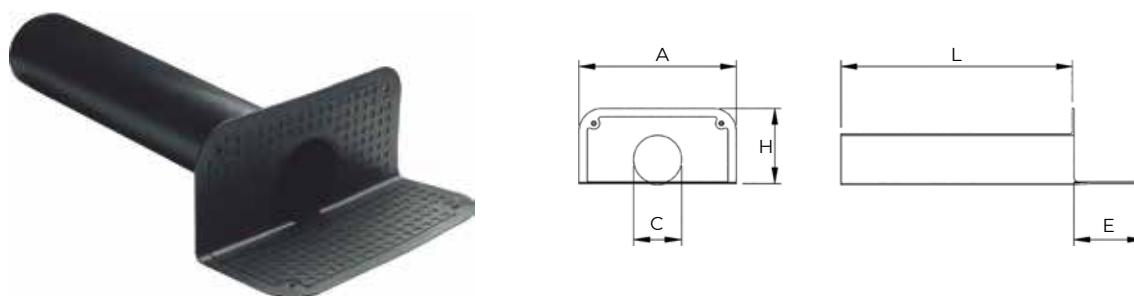

CÓDIGO	Para tubo	A	C	E	H	L	Ud. Embalaje	PVP €/ud.
DHR063TPE	Ø 63	340	63	150	133	500	8	26,62
DHR075TPE	Ø 75	340	75	150	133	500	8	27,57
DHR080TPE	Ø 80	340	80	150	133	500	8	27,86
DHR090TPE	Ø 90	340	90	150	165	500	8	28,34
DHR100TPE	Ø 100	340	100	150	165	500	8	28,84
DHR110TPE	Ø 110	340	110	150	165	500	8	29,44
DHR125TPE	Ø 125	340	125	150	185	500	7	30,72

ACCESORIOS DE IMPERMEABILIZACIÓN DESAGÜES Y ACCESORIOS DE TPE

DESAGÜE HORIZONTAL DE TPE

Desagüe de TPE para láminas asfálticas y de caucho EPDM.



DH10065TPE



DH100100TPE

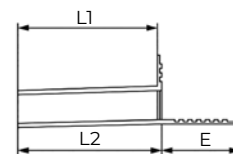
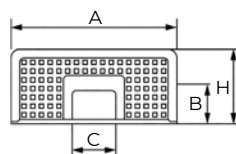

CÓDIGO	Sección	A	B	C	E	H	L1	L2	Ud. Embalaje	PVP €/ud.
DH10065TPE	100 x 65	340	62	92	145	168	425	425	10	22,99
DH100100TPE	100 x 100	340	92	92	145	168	375	375	5	21,89

CÓDIGO	Descripción	Ud. Embalaje	PVP €/ud.
CN6580	Conector Ø 80 para desagüe en ángulo de 90°, sección 100 x 65 mm	10	7,51
CN65100	Conector Ø 100 para desagüe en ángulo de 90°, sección 100 x 65 mm	10	7,54
CN10080	Conector Ø 80 para desagüe en ángulo de 90°, sección 100 x 100 mm	10	6,30
CN100100	Conector Ø 100 para desagüe en ángulo de 90°, sección 100 x 100 mm	10	6,30

CONECTOR



DESAGÜE HORIZONTAL DE TPE PARA BALCONES

Desagüe de TPE para láminas asfálticas y de caucho EPDM.

CÓDIGO	Color	A	B	C	E	H	L	Ud. Embalaje	PVP €/ud.
DHBNTPE	Negro	348	48	57	140	120	347	5	17,49
DHBRTPPE	Rojo	348	48	57	140	120	347	5	17,49
DHBMTPPE	Marfil	348	48	57	140	120	347	5	17,49

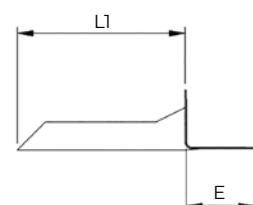
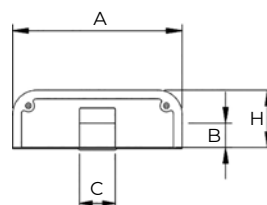

ACCESORIOS DE IMPERMEABILIZACIÓN DESAGÜES Y ACCESORIOS DE TPE

AIREADOR DE TPE

Aireador de TPE para láminas asfálticas y de caucho EPDM.

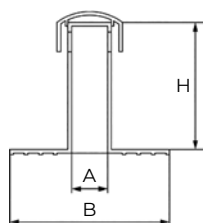

AIRE075TPE



AIRE105TPE



AIRE075HTPE

CÓDIGO	Externo	A	B	H	Ud. Embalaje	PVP €/ud.
AIRE075TPE	Ø 75	72	300	225	25	15,03
AIRE105TPE	Ø 105	100	300	270	20	17,31
AIRE075HTPE	Ø 75	72	300	400	25	21,16

PASATUBOS DE TPE

Pasatubos de TPE para láminas asfálticas y de caucho EPDM.



PROTPE01

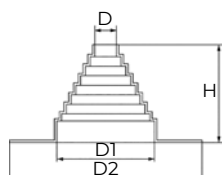

PROTPE02

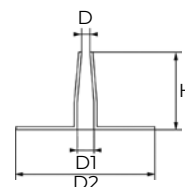

CÓDIGO	D	D1	D2	H	Ud. Embalaje	PVP €/ud.
PROTPE01	40	175	395	190	12	16,78
PROTPE02	15	30	210	120	50	5,89

ESQUINAS DE TPE

Esquinas de TPE para láminas asfálticas y de caucho EPDM.

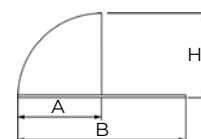
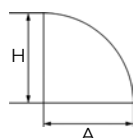

CÓDIGO	Tipo	A	B	H	Ud. Embalaje	PVP €/ud.
EITPE	Ángulo interno	95	-	95	200	1,99
EETPE	Ángulo externo	93	173	100	100	2,68

ACCESORIOS DE IMPERMEABILIZACIÓN DESAGÜES Y ACCESORIOS DE PVC

DESAGÜE VERTICAL DE PVC

Desagüe vertical de PVC para láminas de PVC.

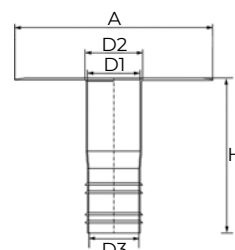
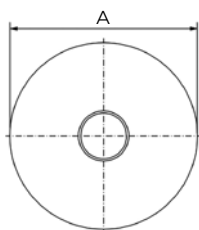

CÓDIGO	Para tubo	A	D1	D2	D3	H	Ud. Embalaje	PVP €/ud.
DV063PVC	Ø 63	320	51	60	49	250	15	16,21
DV075PVC	Ø 75	320	63	70	62	250	15	16,54
DV082PVC	Ø 82	320	69	75	68	250	15	17,01
DV090PVC	Ø 90	320	80	84	79	250	15	18,11
DV100PVC	Ø 100	320	86	90	85	250	15	18,74
DV110PVC	Ø 110	380	95	101	94	250	15	21,08
DV125PVC	Ø 125	380	109	115	108	250	15	21,34
DV140PVC	Ø 140	380	128	134	127	250	10	22,84
DV150PVC	Ø 150	380	134	140	132	250	10	24,16
DV160PVC	Ø 160	380	140	146	139	250	8	25,99

DESAGÜE HORIZONTAL TUBO REDONDO DE PVC

Desagüe horizontal tubo redondo de PVC para láminas de PVC.

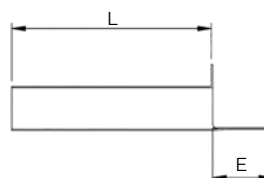
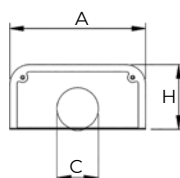

CÓDIGO	Para tubo	A	C	E	H	L	Ud. Embalaje	PVP €/ud.
DHR063PVC	Ø 63	340	63	150	133	500	8	32,15
DHR075PVC	Ø 75	340	75	150	133	500	8	32,29
DHR090PVC	Ø 90	340	90	150	165	500	8	37,38
DHR110PVC	Ø 110	340	110	150	165	500	8	39,21
DHR125PVC	Ø 125	340	125	150	165	500	7	42,10

ACCESORIOS DE IMPERMEABILIZACIÓN DESAGÜES Y ACCESORIOS DE PVC

DESAGÜE HORIZONTAL DE PVC

Desagüe de PVC para láminas de PVC.



DH10065PVC



DH100100PVC

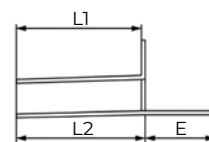
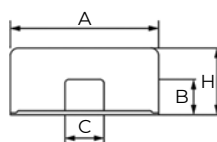

CÓDIGO	Sección	A	B	C	E	H	L1	L2	Ud. Embalaje	PVP €/ud.
DH10065PVC	100 x 65	340	62	92	145	168	425	425	8	27,25
DH100100PVC	100 x 100	340	92	92	145	168	375	375	5	25,27

CONECTOR



CÓDIGO	Descripción	Ud. Embalaje	PVP €/ud.
CN6580	Conector Ø 80 para desagüe en ángulo de 90°, sección 100 x 65 mm	10	7,51
CN65100	Conector Ø 100 para desagüe en ángulo de 90°, sección 100 x 65 mm	10	7,54
CN10080	Conector Ø 80 para desagüe en ángulo de 90°, sección 100 x 100 mm	10	6,30
CN100100	Conector Ø 100 para desagüe en ángulo de 90°, sección 100 x 100 mm	10	6,30

PASATUBOS DE PVC

Pasatubos de PVC para láminas de PVC.



PROPVC01

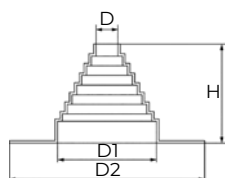

PROPVC02

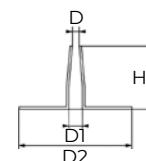

CÓDIGO	D	D1	D2	H	Ud. Embalaje	PVP €/ud.
PROPVC01	40	175	395	190	12	18,11
PROPVC02	15	30	210	120	50	5,35

ACCESORIOS DE IMPERMEABILIZACIÓN DESAGÜES Y ACCESORIOS DE PVC

AIREADOR DE PVC

Aireador de PVC para láminas de PVC.

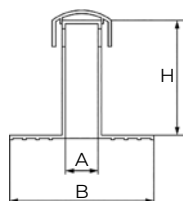

AIRE075PVC



AIRE105PVC



AIRE075HPVC

CÓDIGO	Externo	A	B	H	Ud. Embalaje	PVP €/ud.
AIRE075PVC	Ø 75	72	300	225	20	17,86
AIRE105PVC	Ø 105	100	300	270	15	20,84
AIRE075HPVC	Ø 75	72	300	400	12	22,26

ESQUINAS DE PVC

Esquinas de PVC para láminas de PVC.



EIPVC

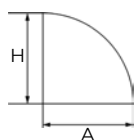

EEPVC

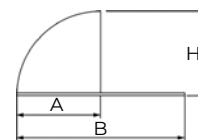

CÓDIGO	Tipo	A	B	H	Ud. Embalaje	PVP €/ud.
EIPVC	Ángulo interno	95	-	95	200	2,09
EEPVC	Ángulo externo	93	173	100	100	2,59

ACCESORIOS DE IMPERMEABILIZACIÓN DESAGÜES Y ACCESORIOS DE TPO

DESAGÜE VERTICAL DE TPO

Desagüe vertical de poliolefina de color blanca compatible con láminas de TPO HIFAX.

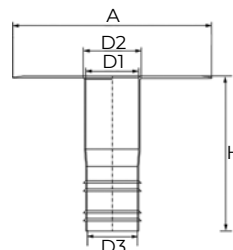
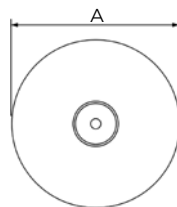

CÓDIGO	Para tubo	A	D1	D2	D3	H	Ud. Embalaje	PVP €/ud.
DV063TPO	Ø 63	320	51	60	49	250	15	16,21
DV075TPO	Ø 75	320	63	70	62	250	15	16,68
DV082TPO	Ø 82	320	69	75	68	250	15	17,16
DV090TPO	Ø 90	320	80	84	79	250	15	18,19
DV100TPO	Ø 100	320	86	90	85	250	15	18,74
DV110TPO	Ø 110	380	95	101	94	250	15	20,53
DV125TPO	Ø 125	380	109	115	108	250	15	21,38
DV140TPO	Ø 140	380	128	134	127	250	10	23,47
DV150TPO	Ø 150	380	134	140	132	250	10	23,94
DV160TPO	Ø 160	380	140	146	139	250	10	25,12

DESAGÜE HORIZONTAL DE TPO

Desagüe horizontal de poliolefina de color blanca compatible con láminas de TPO HIFAX.

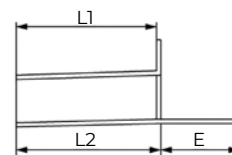
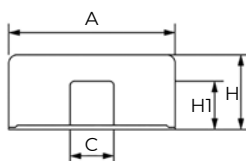

CÓDIGO	Sección	A	B	C	E	H	L1	L2	Ud. Embalaje	PVP €/ud.
DH10065TPO	100 x 65	340	62	92	145	168	425	425	8	25,48

CONECTOR



CÓDIGO	Descripción	Ud. Embalaje	PVP €/ud.
CN6580	Conector Ø 80 para desagüe en ángulo de 90°, sección 100 x 65 mm	10	7,51
CN65100	Conector Ø 100 para desagüe en ángulo de 90°, sección 100 x 65 mm	10	7,54

ACCESORIOS DE IMPERMEABILIZACIÓN DESAGÜES Y ACCESORIOS DE TPO

AIREADOR DE TPO

Aireador de poliolefina de color blanca compatible con láminas de TPO HIFAX.

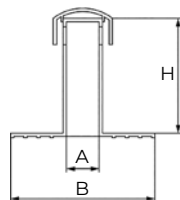

CÓDIGO	Externo	A	B	H	Ud. Embalaje	PVP €/ud.
AIRE075TPO	Ø 75	72	300	225	25	17,71

PASATUBOS DE TPO

Pasatubos de poliolefina de color blanca compatible con láminas de TPO HIFAX.



PROTPO01

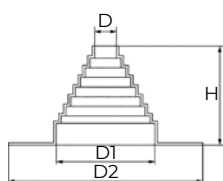

PROTPO02

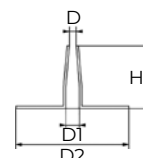

CÓDIGO	D	D1	D2	H	Ud. Embalaje	PVP €/ud.
PROTPO01	40	175	395	190	12	17,01
PROTPO02	15	30	210	120	50	4,88

ESQUINAS DE TPO

Esquinas de poliolefina de color blanca compatible con láminas de TPO HIFAX.



EITPO

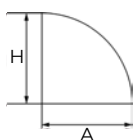

EETPO

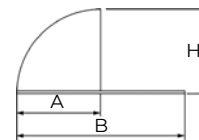

CÓDIGO	Tipo	A	B	H	Ud. Embalaje	PVP €/ud.
EITPO	Ángulo interno	95	-	95	200	2,93
EETPO	Ángulo externo	93	173	100	100	3,78

ACCESORIOS DE IMPERMEABILIZACIÓN PARAHOJAS Y PARAGRAVAS

PARAHOJAS UNIVERSAL DE POLIPROPILENO

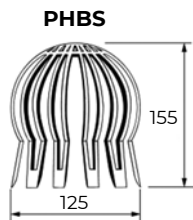
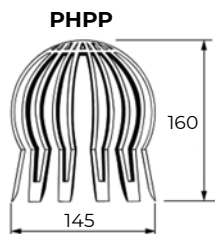

CÓDIGO	Ø Nominal	Ud. Embalaje	PVP €/ud.
PHPP	60 - 140	100	1,84
PHBS	60 - 120	150	1,19

PARAHOJAS UNIVERSAL METÁLICO

CÓDIGO	Ø Nominal	Ud. Embalaje	PVP €/ud.
PHAI	Acero inoxidable	50	20,56
PHAZ	Acero zincado	50	9,29

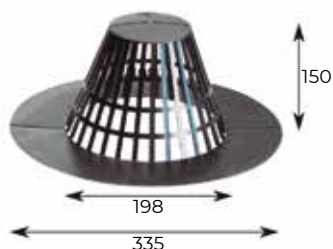
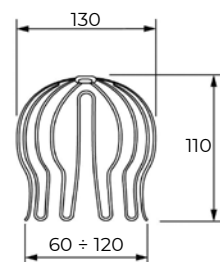

PARAGRAVAS MODELO ESPAÑA

CÓDIGO	Descripción	Ud. Embalaje	PVP €/ud.
PGESP	Paragrasas España	25	7,11

PARAGRAVAS BANDERA

Paragrasas componible de polipropileno, necesita el asta, para que se pueda conectar al tubo de salida.

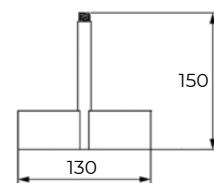
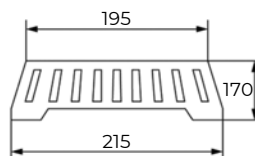
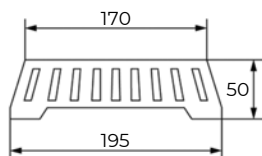

CÓDIGO	Descripción	Ud. Embalaje	PVP €/ud.
PGUNI	Paragrava	50	3,50
PGPRL	Prolongador	50	3,41
PGAST	Asta	50	3,31

ACCESORIOS DE IMPERMEABILIZACIÓN PARAHOJAS Y PARAGRAVAS

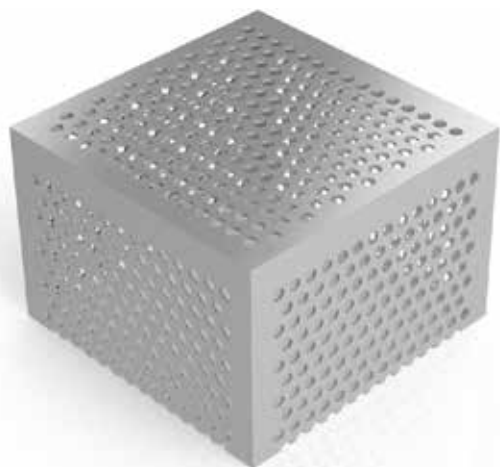

PARAGRAVAS DE ACERO INOXIDABLE

Paragrasas y marco de 150 x 150 x 150 mm de acero inoxidable AISI304. Perforaciones de 6 mm.

CÓDIGO	Ud. Embalaje	PVP €/ud.
PG1515FAI	6	55,48

PARAGRAVAS DE ACERO INOXIDABLE REGISTRABLE

Paragrasas de 200 x 200 x 200 mm de acero inoxidable AISI304. Parte superior de 200 x 200 x 20 mm extraíble. Perforaciones de 6 mm.

CÓDIGO	Ud. Embalaje	PVP €/ud.
PG2020EAI	6	82,21

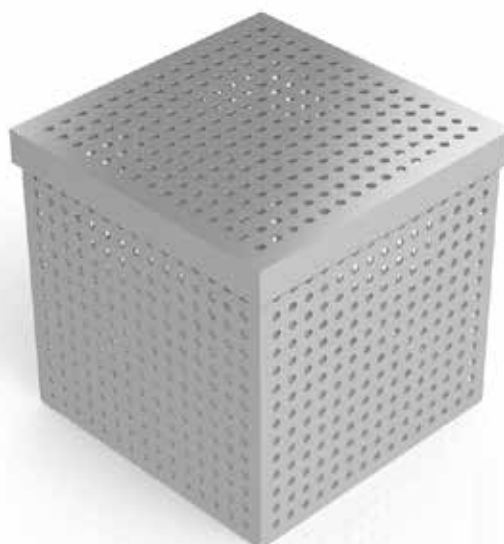

REJILLA PARAGRAVAS DE ACERO INOXIDABLE REGISTRABLE

Rejilla paragrasas y marco de 200 x 200 x 20 mm de acero inoxidable. Perforaciones de 6 mm.

CÓDIGO	Ud. Embalaje	PVP €/ud.
PG2020MAI	6	47,28



ACCESORIOS TEJADOS Y CUBIERTAS

PROTECTOR ANTIAVES

PM080PP

PM110SP

PM110AI

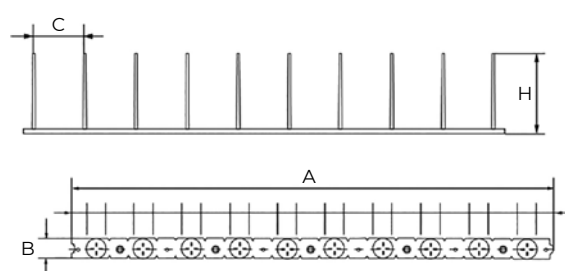
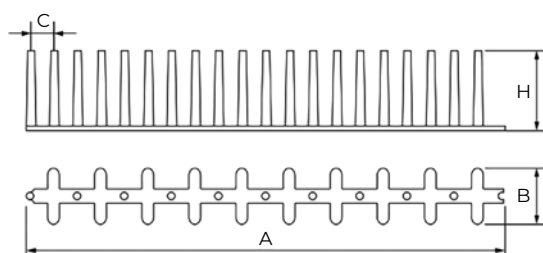
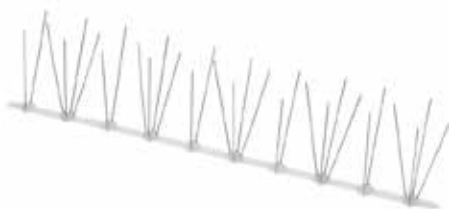

CÓDIGO	Composición		A	B	C	H	Ud. Embalaje	PVP €/ud.
	Base	Púas						
PM080PP	Polietileno de alta densidad	Polietileno de alta densidad	500	55	25	80	100 *	1,29
PM110SP	Polycarbonato	Inox	500	20	50	110	60	3,49
PM110AI	Inox	Inox	1000	20	50	110	25	6,61

* El artículo PM080PP se suministra por cajas completas.

PEINE ANTINIDOS

Peine antinidos fabricado en polietileno de alta densidad color negro.

CÓDIGO	A	B	H	Ud. Embalaje	PVP €/ud.
PA070PP	500	20	70	220	0,67
PA110PP	500	20	110	160	0,76
PA150PP	500	20	150	100	1,07

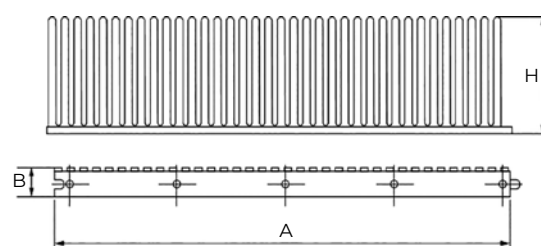

ACCESORIOS DE IMPERMEABILIZACIÓN CAZOLETAS DE PVC RÍGIDAS

CAZOLETAS DE PVC



CAZOLETA VERTICAL/HORIZONTAL

CÓDIGO	Rejilla	Ø Salida	H1	H2	A	B	Ud. Emb.	PVP €/ud.
CZL050VH	100 x 100	Ø 50/40	50	90	110	160	6	11,27

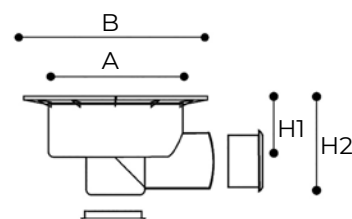

CAZOLETA VERTICAL

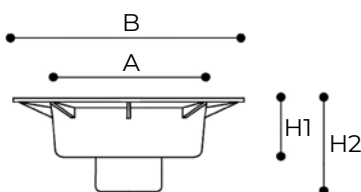

CÓDIGO	Rejilla	Ø Salida	H1	H2	A	B	Ud. Emb.	PVP €/ud.
CZL075V	150 x 150	Ø 75	65	122	140	220	6	7,14
CZL090V	200 x 200	Ø 90	80	135	180	290	6	13,31
CZL110V	250 x 250	Ø 110	80	145	220	350	6	13,79

CAZOLETA HORIZONTAL

CÓDIGO	Rejilla	Ø Salida	H1	H2	A	B	Ud. Emb.	PVP €/ud.
CZL075H	150 x 150	Ø 75	65	110	140	220	6	8,17
CZL090H	200 x 200	Ø 90	80	135	180	290	6	13,79
CZL110H	250 x 250	Ø 110	80	145	220	350	6	16,37

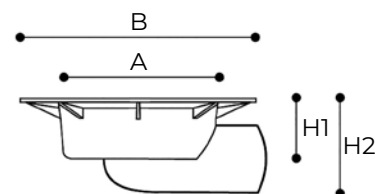

CAZOLETA, SUMIDERO SIFÓNICO DE PVC Y PARAHOJAS



CÓDIGO	Tamaño	Descripción	Ud. Emb.	PVP €/ud.
CZPH090V	200 x 200 Vertical	Cazoleta con sumidero y parahojas de 200x200. Salida vertical Ø 90 mm y altura 180 mm	6	40,25
CZPH110V	250 x 250 Vertical	Cazoleta con sumidero y parahojas de 250x250. Salida vertical Ø 90 - 110 mm y altura 240 mm	6	42,17
CZPH090H	200 x 200 Horizontal	Cazoleta con sumidero y parahojas de 200x200. Salida horizontal Ø 90 mm y altura 180 mm	6	40,74
CZPH110H	250 x 250 Horizontal	Cazoleta con sumidero y parahojas de 250x250. Salida horizontal Ø 110 mm y altura 240 mm	6	44,75

SUMIDERO SIFÓNICO DE PVC Y PARAHOJAS



CÓDIGO	Tamaño	Descripción	Ud. Emb.	PVP €/ud.
SSV20PH	200 x 200	Sumidero de 200 x 200 con parahojas salida Ø 90 mm y altura 85 mm	6	28,58
SSV25PH	250 x 250	Sumidero de 250 x 250 con parahojas salida Ø 90 - 110 mm y altura 85 mm	6	30,09

ACCESORIOS DE IMPERMEABILIZACIÓN

CLAVO TACO DE EXPANSIÓN PARA PANEL AISLANTE

Fijación de aislamiento de polipropileno $\varnothing 10$ con clavo de plástico reforzado. Específico para paneles aislantes rígidos. Para materiales macizos sugerimos hacer agujeros $\varnothing 12$ mm.

NOVEDAD

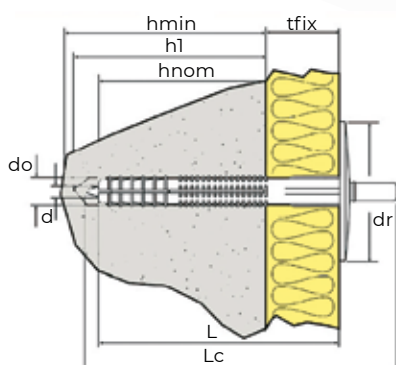

- do Diámetro
- tfix Espesor a fijar
- h1 Mínima profundidad del taladro
- hnom Profundidad de empotramiento
- hmin Mínimo espesor del material base
- dr Diámetro de arandela
- df Diámetro de agujero en pieza a fijar
- L Longitud

Código	Ud. Emb.	do x L (mm)	Tfix Min. (mm)	Tfix Max (mm)	H1 (mm)	Hnom (mm)	Hmin (mm)	Dr (mm)	PVP €/ud.
CTE070	250	10 x 70	20	45	40	30	80	50	0,14
CTE090	250	10 x 90	40	65	40	30	80	50	0,17
CTE110	250	10 x 110	70	95	40	30	80	50	0,20
CTE130	250	10 x 130	90	110	40	30	80	50	0,22
CTE150	250	10 x 150	115	130	40	30	80	50	0,29
CTE180	250	10 x 180	130	155	40	30	80	50	0,35

FIJACIONES PARA LÁMINAS IMPERMEABILIZANTES

Perfil y pletina de acero galvanizado y plastificado colaminado con PVC, para fijación de láminas de EPDM, PVC y asfalto.

Perfil



Pletina



CÓDIGO	Descripción	Ud. Embalaje	PVP €/ud.
PFAZ12	Perfil galvanizado de 2000 x 50 x 1,2 mm, con perforaciones $\varnothing 6$ mm. Una perforación cada 200 mm	100	9,92
PFPVC12	Perfil plastificado PVC de 2000 x 50 x 1,2 mm con perforaciones $\varnothing 6$ mm. Una perforación cada 200 mm	100	14,18
PLAZ12	Pletina galvanizada de 2000 x 50 x 1,2 mm, con perforaciones $\varnothing 6$ mm. Una perforación cada 200 mm	100	5,95
PLPVC12	Pletina plastificada PVC de 2000 x 50 x 1,2 mm con perforaciones $\varnothing 6$ mm. Una perforación cada 200 mm	100	7,66