

DRENAJE PUNTUTAL DE PLÁSTICO

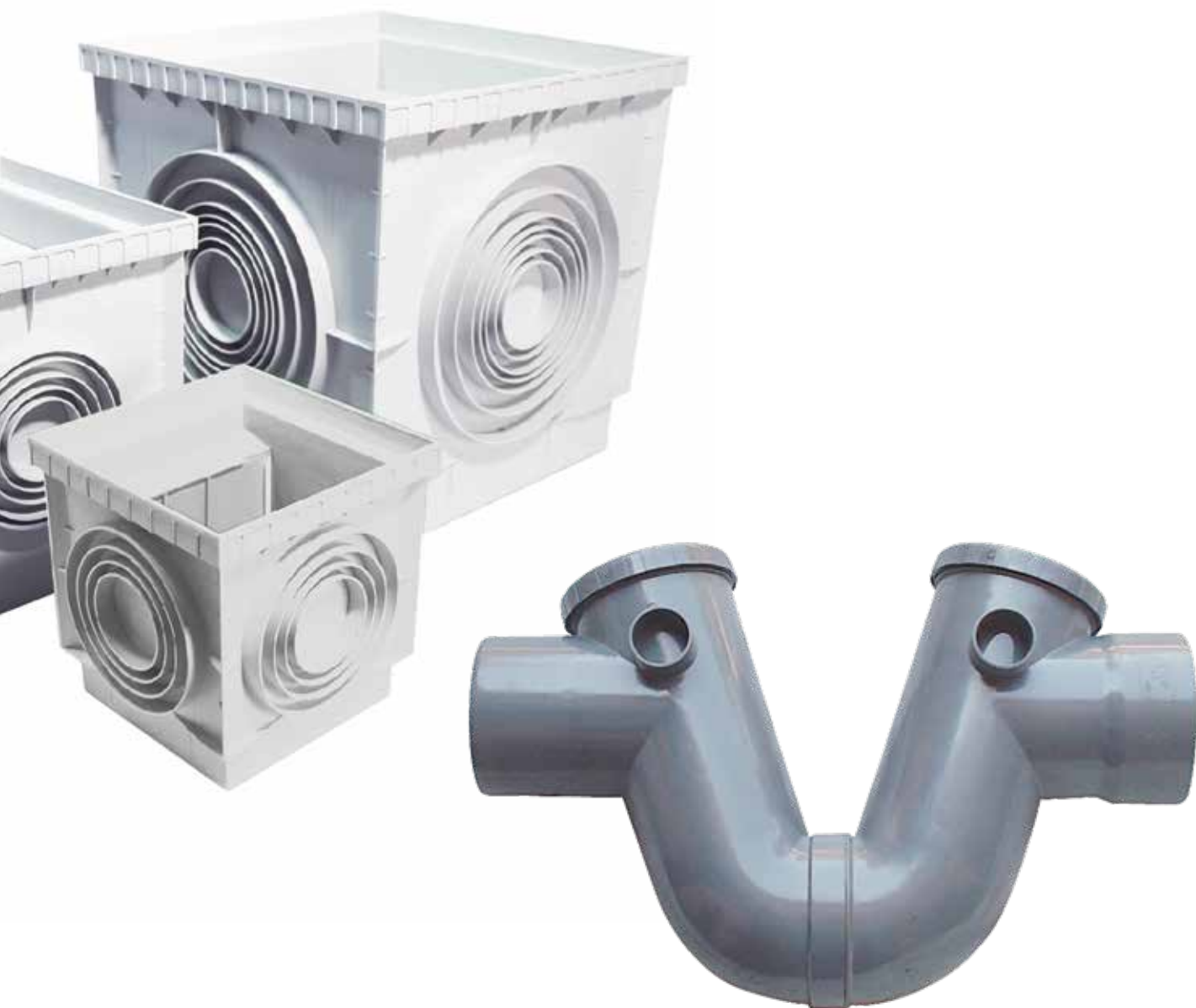

DRENAJE PUNTUAL DE PLÁSTICO



ÍNDICE



**ARQUETA DE
POLIPROPILENO Y
COMPLEMENTOS** 110



**ARQUETA PARA CABLES
ELÉCTRICOS** 114



**TAPAS, REJILLAS
Y MARCOS DE
POLIPROPILENO** 111



ARQUETA PLUVIAL 114



**TAPAS DE FUNDICIÓN
PARA ARQUETA** 112



**SUMIDEROS SIFÓNICOS
DE POLIPROPILENO
Y PVC** 115



**TAPAS CON SUMIDERO
Y MARCO** 112



CAZOLETAS 117



**TAPA RELLENABLE
Y MARCO** 112



**PUERTA CONTADOR
DE ABS** 118



TAPAS HERMÉTICAS 113



SIFÓN EN LINEA DE PVC 118

DRENAJE PUNTUAL DE PLÁSTICO

ARQUETA DE POLIPROPILENO

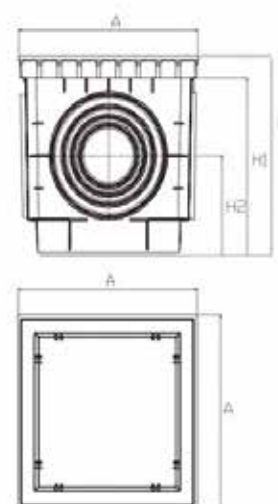

CÓDIGO	Tamaño	A	H	H1	H2	Ø Entradas/Salidas	Ud. Embalaje
ARQ20S	200 x 200	196	200	180	100	50 - 63 - 80 - 100 - 125	12
ARQ30S	300 x 300	292	295	273	147	63 - 80 - 100 - 125 - 140	12
ARQ40S	400 x 400	394	394	368	196	80 - 100 - 125 - 140 - 160 - 200 - 250	12
ARQ55S	550 x 550	545	520	484	266	160 - 200 - 250 - 315	12

PLACA SIFÓNICA PARA ARQUETA DE POLIPROPILENO

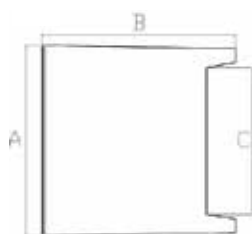

CÓDIGO	Tamaño	A	B	C	H	Ud. Embalaje
PS20S	200 x 200	156	166	123	26	12
PS30S	300 x 300	248	252	191	47	12
PS40S	400 x 400	345	350	-	52,5	12
PS55S	550 x 550	485	335	-	85	12

DRENAJE PUNTUAL DE PLÁSTICO

TAPAS, REJILLAS Y MARCOS DE POLIPROPILENO

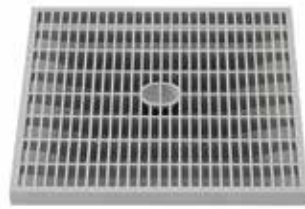

TAPA

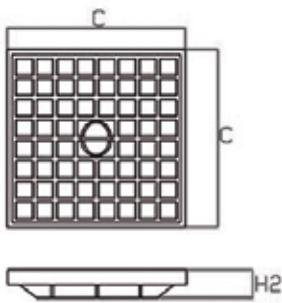

CÓDIGO	Tamaño	A	H	Ud. Embalaje
TAPA20S	200 x 200	185	25	12
TAPA30S	300 x 300	280	28	12
TAPA40S	400 x 400	380	33	12
TAPA55S *	550 x 550	530	56	12

*La tapa de 550 x 550 mm dispone de un perno central para facilitar su apertura.

REJILLA

CÓDIGO	Tamaño	A	H	Ud. Embalaje
REJA20S	200 x 200	185	25	12
REJA30S	300 x 300	280	28	12
REJA40S	400 x 400	380	33	12
REJA55S *	550 x 550	530	56	12

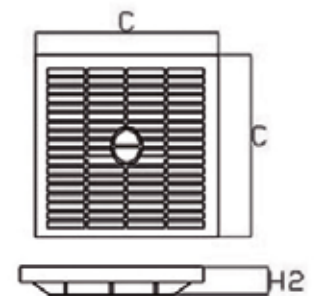

*La rejilla de 550 x 550 mm dispone de un perno central para facilitar su apertura.

MARCO PARA TAPA Y REJILLA

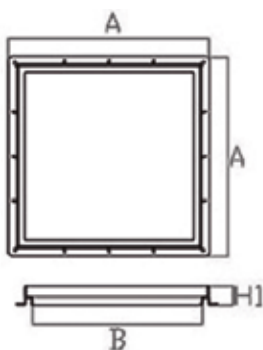

CÓDIGO	Tamaño	A	B	H	Ud. Embalaje
MARCO20S	200 x 200	212	165	39	12
MARCO30S	300 x 300	325	252	40	12
MARCO40S	400 x 400	427	386	42	12
MARCO55S	550 x 550	584	543	52	12

DRENAJE PUNTUAL DE PLÁSTICO

TAPA DE FUNDICIÓN PARA ARQUETA DE POLIPROPILENO

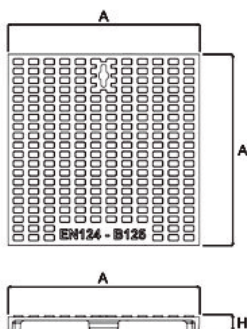

CÓDIGO	Tamaño	A	H	Clase de carga	Ud. Embalaje
TF20KB	200 x 200	185	19	B125	12
TF30KB	300 x 300	280	20	B125	12
TF40KB	400 x 400	380	27	B125	12
TF55KB	550 x 550	530	36	B125	12

TAPA CON SUMIDERO Y MARCO

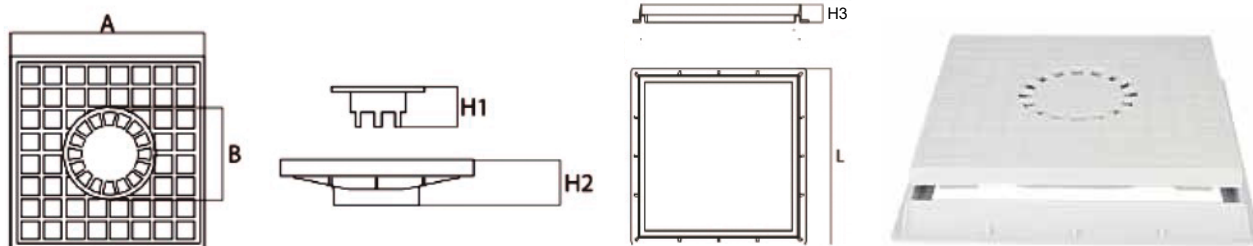

CÓDIGO	Tamaño	A	B	L	H1	H2	H3	Ud. Embalaje
TAPA30SS	300 x 300	280	135	315	55	60	40	12
TAPA40SS	400 x 400	380	175	435	76	85	45	12

TAPA RELLENABLE Y MARCO

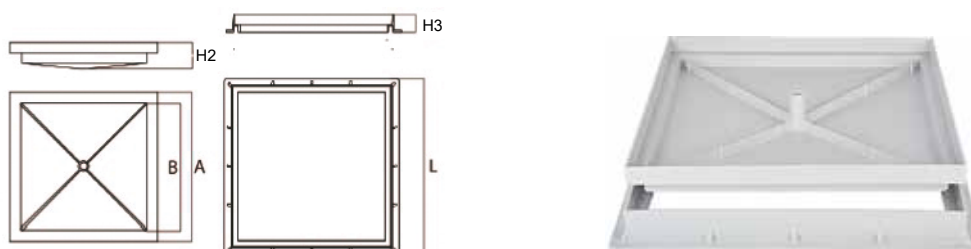

CÓDIGO	Tamaño	A	B	L	H2	H3	Ud. Embalaje
T130S	300 x 300	285	24	315	55	40	12
T140S	400 x 400	385	36	435	55	45	12

DRENAJE PUNTUAL DE PLÁSTICO

TAPA HERMÉTICA CON TORNILLOS, JUNTA DE CAUCHO Y MARCO

Tapa hermética y marco, ambos fabricados en ABS, con junta de goma y 4 tornillos.

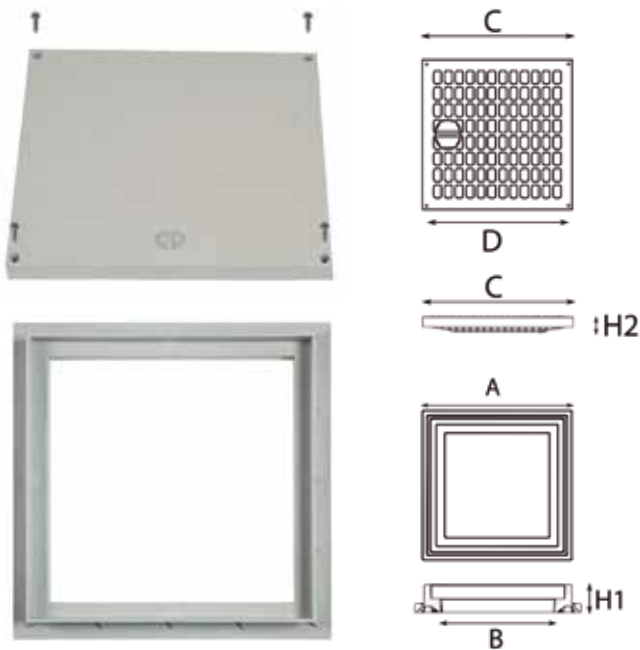

Tamaño	A	B	H1	C	D	H2
200 x 200	232	160	38	185	167	29
300 x 300	330	250	41	280	272	38
400 x 400	439	345	44	380	362	42
550 x 550	603	476	67	530	507	49

CÓDIGO	Tamaño	Descripción	Ud. Embalaje
TAPA20SH	200 x 200	Tapa hermética + junta + tornillos + marco 200	12
TAPA30SH	300 x 300	Tapa hermética + junta + tornillos + marco 300	12
TAPA40SH	400 x 400	Tapa hermética + junta + tornillos + marco 400	12
TAPA55SH	550 x 550	Tapa hermética + junta + tornillos + marco 550	12

TAPA HERMÉTICA CON TORNILLOS, JUNTA DE CAUCHO Y ARQUETA

Tapa hermética de ABS, con junta de goma, 4 tornillos y arqueta de polipropileno.



CÓDIGO	Tamaño	Descripción	Ud. Embalaje
ARQ20SH	200 x 200	Tapa hermética + junta + tornillos + arqueta 200	12
ARQ30SH	300 x 300	Tapa hermética + junta + tornillos + arqueta 300	12
ARQ40SH	400 x 400	Tapa hermética + junta + tornillos + arqueta 400	12
ARQ55SH	550 x 550	Tapa hermética + junta + tornillos + arqueta 550	12

DRENAJE PUNTUAL DE PLÁSTICO

ARQUETA DE POLIPROPILENO PARA CABLES ELÉCTRICOS

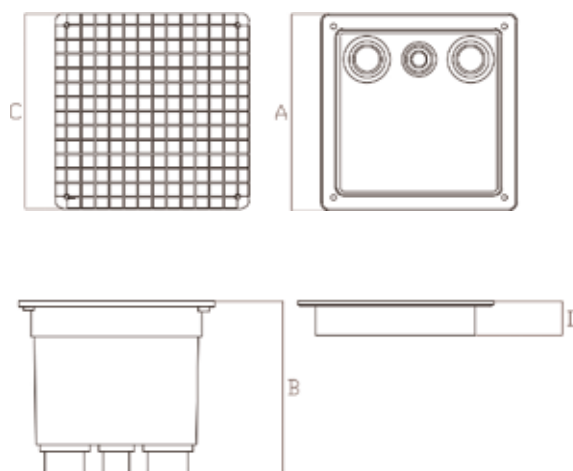

CÓDIGO	Tamaño	A	B	C	D	Ud. Embalaje
ARQ25PPE	250 x 250	275	240	271	48	12

ARQUETA PLUVIAL DE POLIPROPILENO



Ø 80-100
Ø 90-110
Ø 110-125



80-100

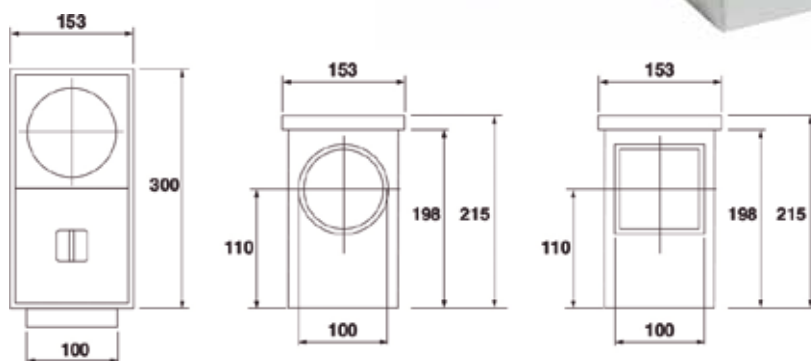

CÓDIGO	Entrada de tubo	Salida de tubo	Ud. Embalaje
APS080100	Ø 80 - 100	Ø 100	12
APS090110	Ø 90 - 110	Ø 100	12
APS110125	Ø 110 - 125	Ø 100	12
APSQ80100	Ø 80 - 100	Ø 100	12
APSRACOR	Ø 100	Ø 100	12

DRENAJE PUNTUAL DE PLÁSTICO

SUMIDERO SIFÓNICO DE POLIPROPILENO SALIDA VERTICAL



CÓDIGO	Tamaño	A	B	C	H	Desagüe	Ud. Embalaje
SSV10PP	100 x 100	100	90	80	46	Ø 32 - 40	48
SSV15PP	150 x 150	150	135	125	58	Ø 40 - 50 - 63	32
SSV20PP	200 x 200	200	180	150	75	Ø 80 - 100 - 110	28
SSV25PP	250 x 250	250	190	190	82	Ø 100 - 110	24
SSV30PP	300 x 300	300	220	220	100	Ø 100 - 110 - 125	30

SUMIDERO SIFÓNICO DE PVC CON SALIDA VERTICAL/HORIZONTAL Y EMBELLECEDOR DE ACERO INOXIDABLE

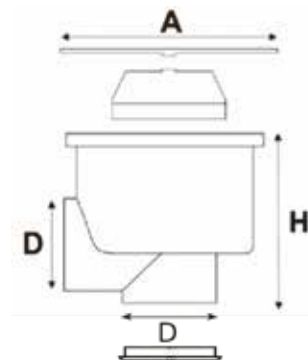

CÓDIGO	Medidas	Ø Salida	A	D	H	Ud. Embalaje
SSEIPVC	115 x 115	Ø 40/50	115	50	98	27

DRENAJE PUNTUAL DE PLÁSTICO

SUMIDERO SIFÓNICO DE POLIPROPILENO CON SALIDA HORIZONTAL



SUMIDERO CON REJILLA DE PLÁSTICO

CÓDIGO	Tamaño	A	B	D	H	Desagüe	Ud. Embalaje
SSH10PP	115 x 115	110	106	50	71	Ø 50	40
SSH15PP	150 x 150	150	146	50	71	Ø 50	48
SSH20PP	200 x 200	200	168	50	72	Ø 50	25
SSH25PP	250 x 250	250	212	63	90	Ø 63	12
SSH30PP	300 x 300	300	259	80	110	Ø 80	8

SUMIDERO TELESCÓPICO CON REJILLA DE PLÁSTICO

CÓDIGO	Tamaño	A	B	D	H (min. y max.)	Desagüe	Ud. Embalaje
SSH10PPT	115 x 115	110	106	50	71 - 110	Ø 50	24
SSH15PPT	150 x 150	150	146	50	71 - 110	Ø 50	28



SUMIDERO CON REJILLA DE ACERO INOXIDABLE

CÓDIGO	Tamaño	A	B	D	H	Desagüe	Ud. Embalaje
SSH10PPI	115 x 115	110	106	50	71	Ø 50	40
SSH15PPI	150 x 150	150	146	50	71	Ø 50	48

SUMIDERO TELESCÓPICO CON REJILLA DE ACERO INOXIDABLE

CÓDIGO	Tamaño	A	B	D	H (min. y max.)	Desagüe	Ud. Embalaje
SSH10PPIT	115 x 115	110	106	50	71 - 110	Ø 50	24
SSH15PPIT	150 x 150	150	146	50	71 - 110	Ø 50	28

DRENAJE PUNTUAL DE PLÁSTICO

CAZOLETAS DE PVC



CAZOLETA VERTICAL/HORIZONTAL

CÓDIGO	Rejilla	Ø Salida	H1	H2	A	B	Ud. Embalaje
CZL050VH	100 x 100	Ø 50/40	50	90	110	160	6

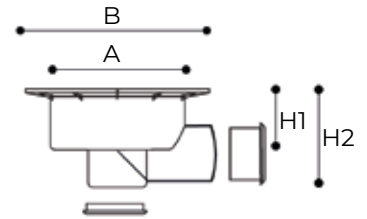

CAZOLETA VERTICAL

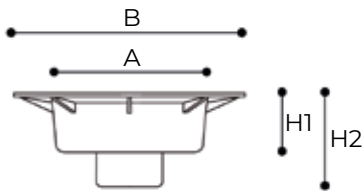

CÓDIGO	Rejilla	Ø Salida	H1	H2	A	B	Ud. Embalaje
CZL075V	150 x 150	Ø 75	65	122	140	220	6
CZL090V	200 x 200	Ø 90	80	135	180	290	6
CZL110V	250 x 250	Ø 110	80	145	220	350	6

CAZOLETA HORIZONTAL

CÓDIGO	Rejilla	Ø Salida	H1	H2	A	B	Ud. Embalaje
CZL075H	150 x 150	Ø 75	65	110	140	220	6
CZL090H	200 x 200	Ø 90	80	135	180	290	6
CZL110H	250 x 250	Ø 110	80	145	220	350	6

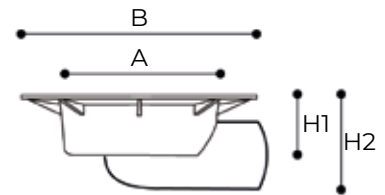

CAZOLETA, SUMIDERO SIFÓNICO DE PVC Y PARAHOJAS



CÓDIGO	Tamaño	Descripción	Ud. Embalaje
CZPH90V	200 x 200 Vertical	Cazoleta con sumidero y parahojas de 200x200. Salida vertical Ø 90 mm y altura 180 mm	6
CZPH110V	250 x 250 Vertical	Cazoleta con sumidero y parahojas de 250x250. Salida vertical Ø 90 - 110 mm y altura 240 mm	6
CZPH90H	200 x 200 Horizontal	Cazoleta con sumidero y parahojas de 200x200. Salida horizontal Ø 90 mm y altura 180 mm	6
CZPH110H	250 x 250 Horizontal	Cazoleta con sumidero y parahojas de 250x250. Salida horizontal Ø 110 mm y altura 240 mm	6

SUMIDERO SIFÓNICO DE PVC Y PARAHOJAS



CÓDIGO	Tamaño	Descripción	Ud. Embalaje
SSV20PH	200 x 200	Sumidero de 200 x 200 con parahojas salida Ø 90 mm y altura 85 mm	6
SSV25PH	250 x 250	Sumidero de 250 x 250 con parahojas salida Ø 90 - 110 mm y altura 85 mm	6

DRENAJE PUNTUAL DE PLÁSTICO

PUERTA CONTADOR DE ABS

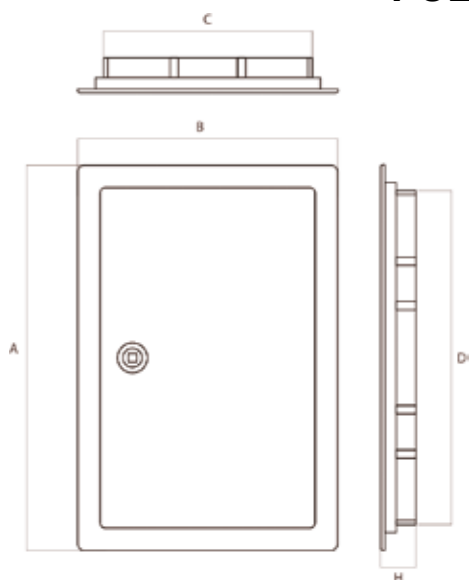

CÓDIGO	A	B	C	D	H	Ud. Embalaje
PC2030	310	210	270	100	30	12
PC3040	460	310	420	200	30	12
PC4050	500	400	460	360	30	12
PC6040	600	400	560	360	30	12

SIFÓN EN LÍNEA DE PVC CON TAPAS DE REGISTRO



CÓDIGO	Ø Salida	Tipo de unión	Ud. Embalaje
SL110	Ø 110	Encolado	6
SL125	Ø 125	Encolado	6
SL160	Ø 160	Encolado	6
SL200	Ø 200	Encolado	6