

ACCESORIOS DE IMPERMEABILIZACIÓN

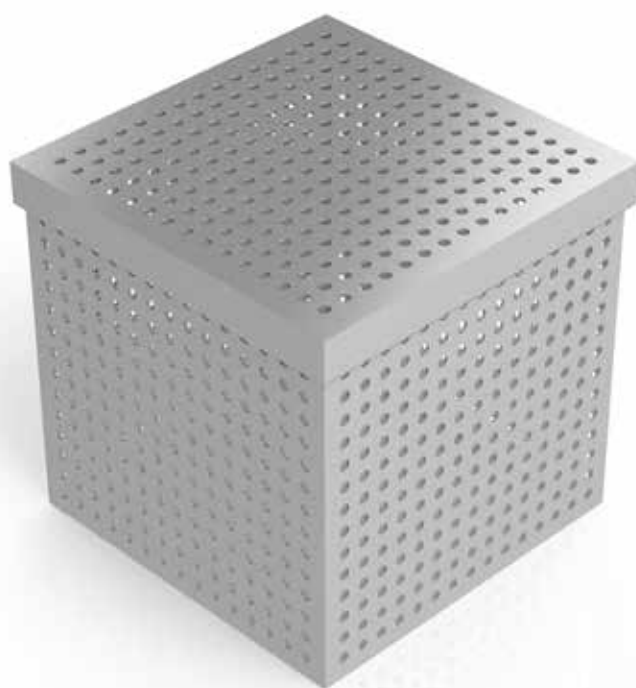

ACCESORIOS DE IMPERMEABILIZACIÓN



ÍNDICE



DESAGÜES FLEXIBLES Y ACCESORIOS DE EPDM

Láminas asfálticas y de EPDM **150**



PARAHOJAS Y PARAGRAVAS

160



DESAGÜES Y ACCESORIOS DE TPE

Láminas asfálticas y de EPDM **152**



PEINE ANTINIDOS Y PROTECTOR DE AVES

162



DESAGÜES Y ACCESORIOS DE PVC

Láminas de PVC **157**



CAZOLETAS DE PVC

163



DESAGÜES Y ACCESORIOS DE TPO

Láminas de TPO **158**



SISTEMAS DE FIJACIÓN LÁMINAS Y AISLAMIENTO

Pletinas, perfiles y clavo-tacos **164**

ACCESORIOS DE IMPERMEABILIZACIÓN DESAGÜES Y ACCESORIOS DE EPDM

DESAGÜE FLEXIBLE DE EPDM

Desagüe flexible y elástico de caucho EPDM vulcanizado, para láminas asfálticas elastoméricas y plastoméricas, H=200 mm.

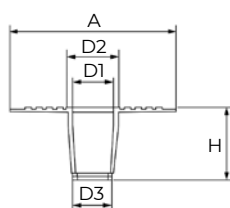
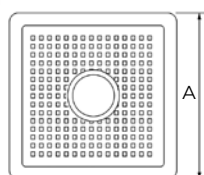

Código	Ø	A	D1	D2	D3	H	Ud. Embalaje
DV040EPDM	40	250	33	39	31	175	25
DV050EPDM	50	310	45	50	42	200	25
DV060EPDM	60	305	51	57	49	200	25
DV075EPDM	75	340	66	72	63	200	25
DV080EPDM	80	330	74	80	70	200	25
DV090EPDM	90	330	80	86	78	200	25
DV100EPDM	100	340	93	99	87	200	25
DV110EPDM	110	340	99	105	94	200	25
DV120EPDM	120	340	113	119	107	200	25
DV125EPDM	125	370	116	122	113	200	20
DV140EPDM	140	370	132	138	124	200	20
DV150EPDM	150	390	140	146	132	200	15
DV160EPDM	160	360	150	156	146	200	15
DV200EPDM	200	440	189	195	179	210	10

PARAHOJAS DE POLIPROPILENO PARA DESAGÜE FLEXIBLE

Parahojas de polipropileno para desagüe flexible y elástico de caucho EPDM vulcanizado.

Código	Ø	A	B	H	Ud. Embalaje
PHD060PP	50-60	47	54	84	25
PHD075PP	75	62	75	105	25
PHD080PP	80	68	70	100	25
PHD090PP	90	78	70	100	25
PHD100PP	100	88	70	100	25
PHD110PP	110	92	70	100	25
PHD120PP	120	100	70	100	25
PHD125PP	125	109	70	100	20
PHD140PP	140	125	70	100	20
PHD150PP	150	130	70	100	15
PHD160PP	160	143	75	105	15
PHD200PP	200	177	75	105	10

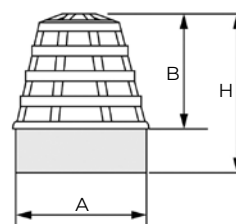

ACCESORIOS DE IMPERMEABILIZACIÓN DESAGÜES Y ACCESORIOS DE EPDM

DESAGÜE FLEXIBLE DE EPDM SIFONADO Y CON PARAHOJAS

Desagüe flexible y elástico de caucho EPDM vulcanizado, para láminas asfálticas elastoméricas y plastoméricas, sifonado y con parahoja.

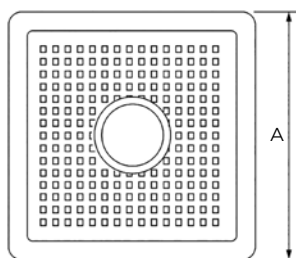
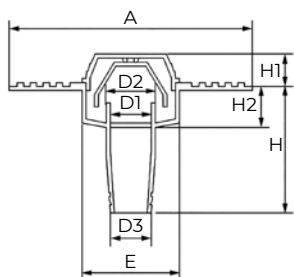

Código	Ø	A	D1	D2	D3	E	H	H2	Ud. Embalaje
DVS080EPDM	80	393	90	97	68	170	205	55	5
DVS090EPDM	90	363	93	100	78	170	205	55	5
DVS100EPDM	100	393	90	100	87	170	205	55	5
DVS110EPDM	110	363	100	107	94	170	205	55	5



ACCESORIOS DE IMPERMEABILIZACIÓN DESAGÜES Y ACCESORIOS DE TPE

DESAGÜE VERTICAL DE TPE

Desagüe vertical de TPE para láminas asfálticas y de caucho EPDM.

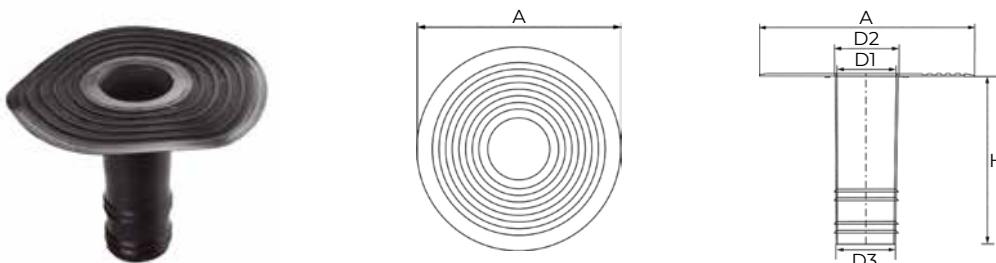

Código	Para tubo	A	D1	D2	D3	H	Ud. Embalaje
DV063TPE	Ø 63	320	51	60	49	250	25
DV075TPE	Ø 75	320	63	70	62	250	25
DV082TPE	Ø 82	320	69	75	68	250	25
DV090TPE	Ø 90	320	80	84	79	250	25
DV100TPE	Ø 100	320	86	90	85	250	25
DV110TPE	Ø 110	380	95	101	94	250	15
DV125TPE	Ø 125	380	109	115	108	250	15
DV140TPE	Ø 140	380	128	134	127	250	10
DV150TPE	Ø 150	380	134	140	132	250	10
DV160TPE	Ø 160	380	140	146	139	250	10

DESAGÜE HORIZONTAL TUBO REDONDO DE TPE

Desagüe de TPE para láminas asfálticas y de caucho EPDM.

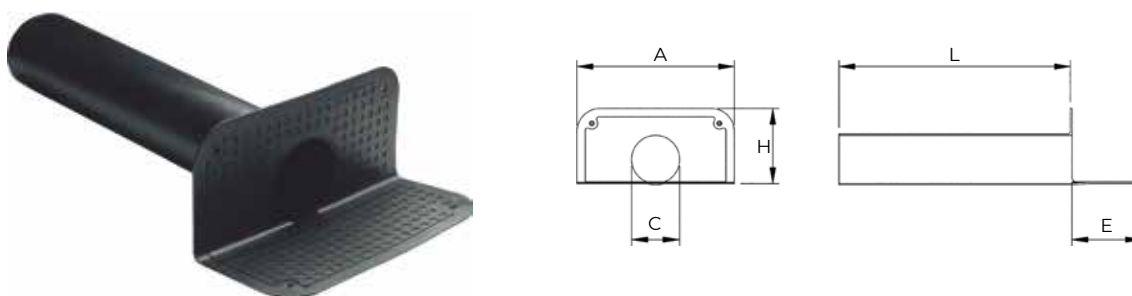

Código	Para tubo	A	C	E	H	L	Ud. Embalaje
DHR063TPE	Ø 63	340	63	150	133	500	8
DHR075TPE	Ø 75	340	75	150	133	500	8
DHR080TPE	Ø 80	340	80	150	133	500	8
DHR090TPE	Ø 90	340	90	150	165	500	8
DHR100TPE	Ø 100	340	100	150	165	500	8
DHR110TPE	Ø 110	340	110	150	165	500	8
DHR125TPE	Ø 125	340	125	150	185	500	7

ACCESORIOS DE IMPERMEABILIZACIÓN DESAGÜES Y ACCESORIOS DE TPE

DESAGÜE HORIZONTAL DE TPE

Desagüe de TPE para láminas asfálticas y de caucho EPDM.



DH10065TPE



DH100100TPE

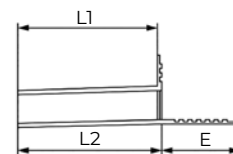
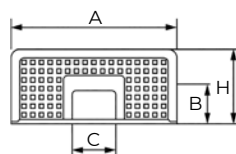

Código	Sección	A	B	C	E	H	L1	L2	Ud. Embalaje
DH10065TPE	100 x 65	340	62	92	145	168	425	425	10
DH100100TPE	100 x 100	340	92	92	145	168	375	375	5

Código	Descripción	Ud. Embalaje
CN6580	Conector Ø 80 para desagüe en ángulo de 90°, sección 100 x 65 mm	10
CN65100	Conector Ø 100 para desagüe en ángulo de 90°, sección 100 x 65 mm	10
CN10080	Conector Ø 80 para desagüe en ángulo de 90°, sección 100 x 100 mm	10
CN100100	Conector Ø 100 para desagüe en ángulo de 90°, sección 100 x 100 mm	10

CONECTOR



DESAGÜE HORIZONTAL DE TPE PARA BALCONES

Desagüe de TPE para láminas asfálticas y de caucho EPDM.

Código	Color	A	B	C	E	H	L	Ud. Embalaje
DHBNTPE	Negro	348	48	57	140	120	347	5
DHBRTPE	Rojo	348	48	57	140	120	347	5
DHBMTPPE	Marfil	348	48	57	140	120	347	5

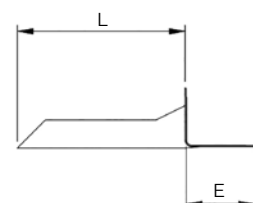
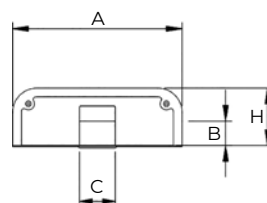

ACCESORIOS DE IMPERMEABILIZACIÓN DESAGÜES Y ACCESORIOS DE TPE

AIREADOR DE TPE

Aireador de TPE para láminas asfálticas y de caucho EPDM.

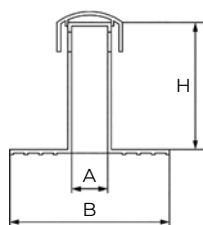

AIRE075TPE



AIRE105TPE



AIRE075HTPE

Código	Externo	A	B	H	Ud. Embalaje
AIRE075TPE	Ø 75	72	300	225	25
AIRE105TPE	Ø 105	100	300	270	20
AIRE075HTPE	Ø 75	72	300	400	25

PASATUBOS DE TPE

Pasatubos de TPE para láminas asfálticas y de caucho EPDM.



PROTPE01

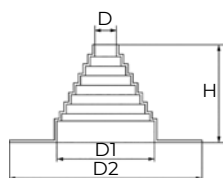

PROTPE02

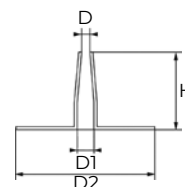

Código	D	D1	D2	H	Ud. Embalaje
PROTPE01	40	175	395	190	12
PROTPE02	15	30	210	120	50

ESQUINAS DE TPE

Esquinas de TPE para láminas asfálticas y de caucho EPDM.

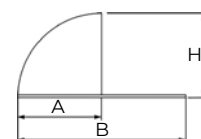
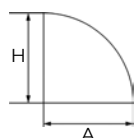

Código	Tipo	A	B	H	Ud. Embalaje
EITPE	Ángulo interno	95	-	95	200
EETPE	Ángulo externo	93	173	100	100

ACCESORIOS DE IMPERMEABILIZACIÓN DESAGÜES Y ACCESORIOS DE PVC

DESAGÜE VERTICAL DE PVC

Desagüe vertical de PVC para láminas de PVC.

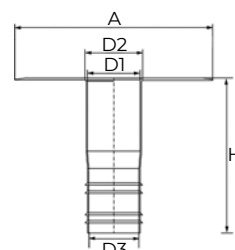
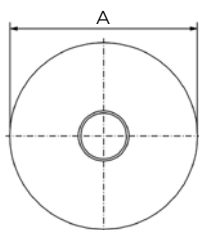

Código	Para tubo	A	D1	D2	D3	H	Ud. Embalaje
DV063PVC	Ø 63	320	51	60	49	250	15
DV075PVC	Ø 75	320	63	70	62	250	15
DV082PVC	Ø 82	320	69	75	68	250	15
DV090PVC	Ø 90	320	80	84	79	250	15
DV100PVC	Ø 100	320	86	90	85	250	15
DV110PVC	Ø 110	380	95	101	94	250	15
DV125PVC	Ø 125	380	109	115	108	250	15
DV140PVC	Ø 140	380	128	134	127	250	10
DV150PVC	Ø 150	380	134	140	132	250	10
DV160PVC	Ø 160	380	140	146	139	250	8

DESAGÜE HORIZONTAL TUBO REDONDO DE PVC

Desagüe horizontal tubo redondo de PVC para láminas de PVC.

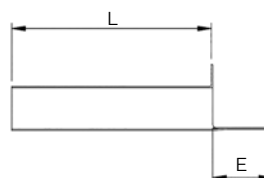
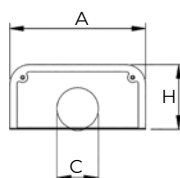

Código	Para tubo	A	C	E	H	L	Ud. Embalaje
DHR063PVC	Ø 63	340	63	150	133	500	8
DHR075PVC	Ø 75	340	75	150	133	500	8
DHR090PVC	Ø 90	340	90	150	165	500	8
DHR110PVC	Ø 110	340	110	150	165	500	8
DHR125PVC	Ø 125	340	125	150	165	500	7

ACCESORIOS DE IMPERMEABILIZACIÓN DESAGÜES Y ACCESORIOS DE PVC

DESAGÜE HORIZONTAL DE PVC

Desagüe de PVC para láminas de PVC.



DH10065PVC



DH100100PVC

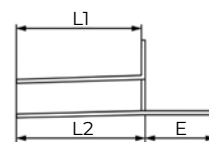
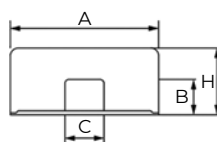

Código	Sección	A	B	C	E	H	L1	L2	Ud. Embalaje
DH10065PVC	100 x 65	340	62	92	145	168	425	425	8
DH100100PVC	100 x 100	340	92	92	145	168	375	375	5

CONECTOR



Código	Descripción	Ud. Embalaje
CN6580	Conector Ø 80 para desagüe en ángulo de 90°, sección 100 x 65 mm	10
CN65100	Conector Ø 100 para desagüe en ángulo de 90°, sección 100 x 65 mm	10
CN10080	Conector Ø 80 para desagüe en ángulo de 90°, sección 100 x 100 mm	10
CN100100	Conector Ø 100 para desagüe en ángulo de 90°, sección 100 x 100 mm	10

PASATUBOS DE PVC

Pasatubos de PVC para láminas de PVC.



PROPVC01

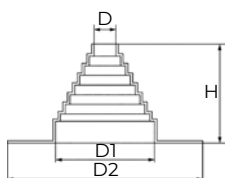

PROPVC02

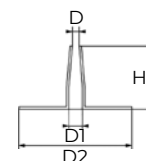

Código	D	D1	D2	H	Ud. Embalaje
PROPVC01	40	175	395	190	12
PROPVC02	15	30	210	120	50

ACCESORIOS DE IMPERMEABILIZACIÓN DESAGÜES Y ACCESORIOS DE PVC

AIREADOR DE PVC

Aireador de PVC para láminas de PVC.

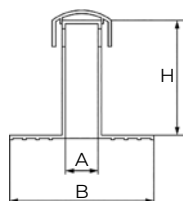

AIRE075PVC



AIRE105PVC



AIRE075HPVC

Código	Externo	A	B	H	Ud. Embalaje
AIRE075PVC	Ø 75	72	300	225	20
AIRE105PVC	Ø 105	100	300	270	15
AIRE075HPVC	Ø 75	72	300	400	12

ESQUINAS DE PVC

Esquinas de PVC para láminas de PVC.



EIPVC



EEPVC

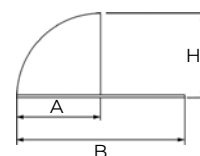
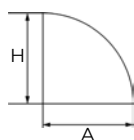

Código	Tipo	A	B	H	Ud. Embalaje
EIPVC	Ángulo interno	95	-	95	200
EEPVC	Ángulo externo	93	173	100	100

ACCESORIOS DE IMPERMEABILIZACIÓN DESAGÜES Y ACCESORIOS DE TPO

DESAGÜE VERTICAL DE TPO

Desagüe vertical de poliolefina de color blanca compatible con láminas de TPO HIFAX.

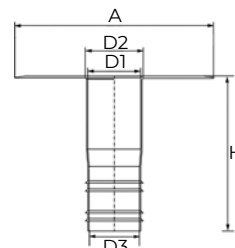
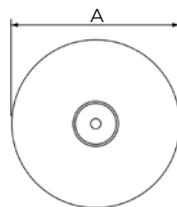

Código	Para tubo	A	D1	D2	D3	H	Ud. Embalaje
DV063TPO	Ø 63	320	51	60	49	250	15
DV075TPO	Ø 75	320	63	70	62	250	15
DV082TPO	Ø 82	320	69	75	68	250	15
DV090TPO	Ø 90	320	80	84	79	250	15
DV100TPO	Ø 100	320	86	90	85	250	15
DV110TPO	Ø 110	380	95	101	94	250	15
DV125TPO	Ø 125	380	109	115	108	250	15
DV140TPO	Ø 140	380	128	134	127	250	10
DV150TPO	Ø 150	380	134	140	132	250	10
DV160TPO	Ø 160	380	140	146	139	250	10

DESAGÜE HORIZONTAL DE TPO

Desagüe horizontal de poliolefina de color blanca compatible con láminas de TPO HIFAX.

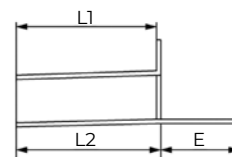
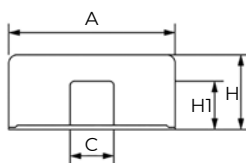

Código	Sección	A	B	C	E	H	L1	L2	Ud. Embalaje
DH10065TPO	100 x 65	340	62	92	145	168	425	425	8

CONECTOR



Código	Descripción	Ud. Embalaje
CN6580	Conector Ø 80 para desagüe en ángulo de 90°, sección 100 x 65 mm	10
CN65100	Conector Ø 100 para desagüe en ángulo de 90°, sección 100 x 65 mm	10

ACCESORIOS DE IMPERMEABILIZACIÓN DESAGÜES Y ACCESORIOS DE TPO

AIREADOR DE TPO

Aireador de poliolefina de color blanca compatible con láminas de TPO HIFAX.

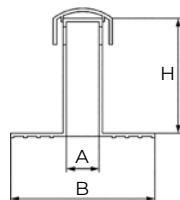

Código	Externo	A	B	H	Ud. Embalaje
AIRE075TPO	Ø 75	72	300	225	25

PASATUBOS DE TPO

Pasatubos de poliolefina de color blanca compatible con láminas de TPO HIFAX.



PROTPO01

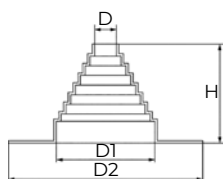

PROTPO02

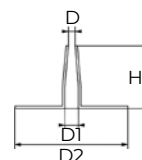

Código	D	D1	D2	H	Ud. Embalaje
PROTPO01	40	175	395	190	12
PROTPO02	15	30	210	120	50

ESQUINAS DE TPO

Esquinas de poliolefina de color blanca compatible con láminas de TPO HIFAX.



EITPO

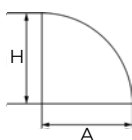

EETPO

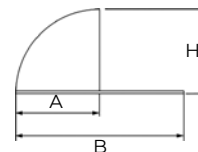

Código	Tipo	A	B	H	Ud. Embalaje
EITPO	Ángulo interno	95	-	95	200
EETPO	Ángulo externo	93	173	100	100

ACCESORIOS DE IMPERMEABILIZACIÓN PARAHOJAS Y PARAGRAVAS

PARAHOJAS UNIVERSAL DE POLIPROPILENO

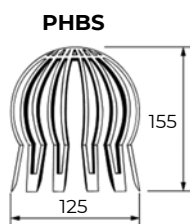
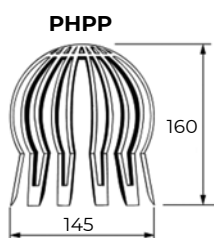

Código	Ø Nominal	Ud. Embalaje
PHPP	60 - 140	100
PHBS	60 - 120	150

PARAHOJAS UNIVERSAL METÁLICO

Código	Material	Ud. Embalaje
PHAI	Acero inoxidable	50
PHAZ	Acero zincado	50

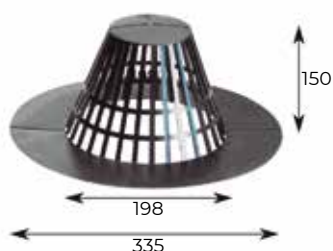
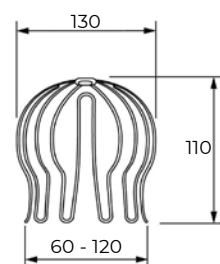

PARAGRAVAS MODELO ESPAÑA

Código	Descripción	Ud. Embalaje
PGESP	Paragras España	25

PARAGRAVAS BANDERA

Paragras componible de polipropileno, necesita el asta, para que se pueda conectar al tubo de salida.

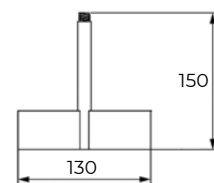
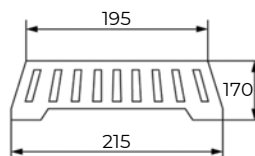
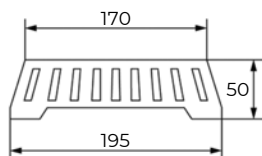

Código	Descripción	Ud. Embalaje
PGUNI	Paragrava	50
PGPRL	Prolongador	50
PGAST	Asta	50

ACCESORIOS DE IMPERMEABILIZACIÓN PARAHOJAS Y PARAGRAVAS

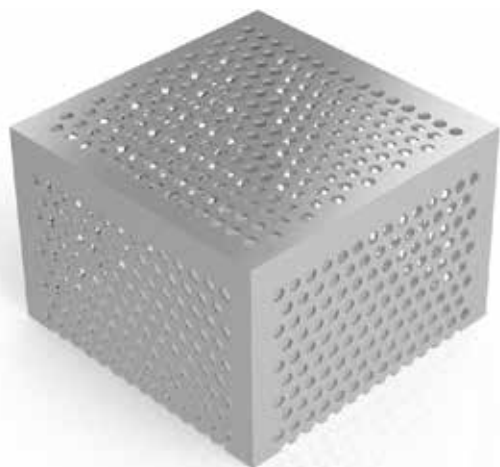

PARAGRAVAS DE ACERO INOXIDABLE

Paragrasas y marco de 150 x 150 x 150 mm de acero inoxidable AISI304. Perforaciones de 6 mm.

Código	Ud. Embalaje
PG1515FAI	6

PARAGRAVAS DE ACERO INOXIDABLE REGISTRABLE

Paragrasas de 200 x 200 x 200 mm de acero inoxidable AISI304. Parte superior de 200 x 200 x 20 mm extraíble. Perforaciones de 6 mm.

Código	Ud. Embalaje
PG2020EAI	6

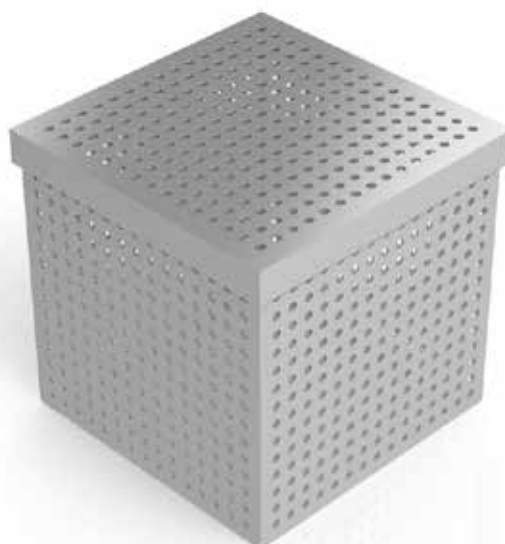

REJILLA PARAGRAVAS DE ACERO INOXIDABLE REGISTRABLE

Rejilla paragrasas y marco de 200 x 200 x 20 mm de acero inoxidable. Perforaciones de 6 mm.

Código	Ud. Embalaje
PG2020MAI	6



ACCESORIOS TEJADOS Y CUBIERTAS

PROTECTOR ANTIAVES

PM080PP

PM110SP

PM110AI

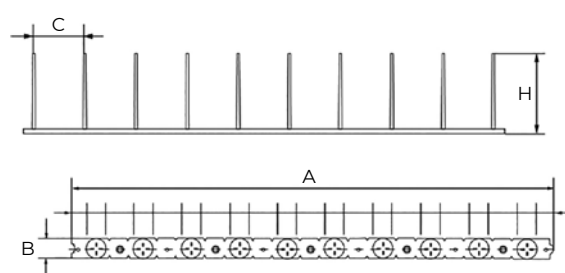
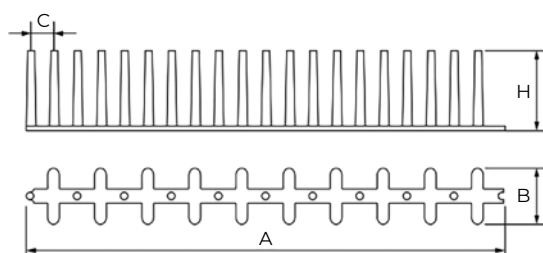

Código	Composición		A	B	C	H	Ud. Embalaje
	Base	Púas					
PM080PP	Polietileno de alta densidad	Polietileno de alta densidad	500	55	25	80	100 *
PM110SP	Polycarbonato	Inox	500	20	50	110	60
PM110AI	Inox	Inox	1000	20	50	110	25

* El artículo PM080PP se suministra por cajas completas.

PEINE ANTINIDOS

Peine antinidos fabricado en polietileno de alta densidad color negro.

Código	A	B	H	Ud. Embalaje
PA070PP	500	20	70	220
PA110PP	500	20	110	160
PA150PP	500	20	150	100

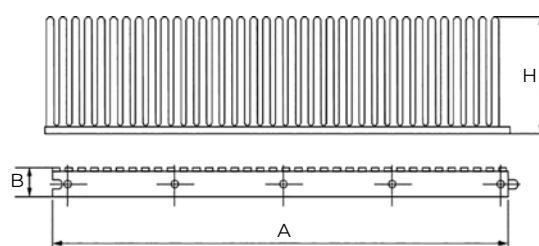

ACCESORIOS DE IMPERMEABILIZACIÓN CAZOLETAS DE PVC RÍGIDAS

CAZOLETAS DE PVC



CAZOLETA VERTICAL/HORIZONTAL

Código	Rejilla	Ø Salida	H1	H2	A	B	Ud. Embalaje
CZL050VH	100 x 100	Ø 50/40	50	90	110	160	6

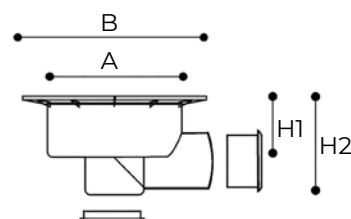

CAZOLETA VERTICAL

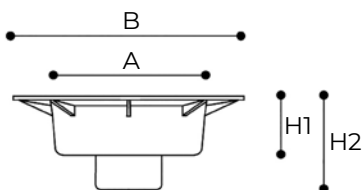

Código	Rejilla	Ø Salida	H1	H2	A	B	Ud. Embalaje
CZL075V	150 x 150	Ø 75	65	122	140	220	6
CZL090V	200 x 200	Ø 90	80	135	180	290	6
CZL110V	250 x 250	Ø 110	80	145	220	350	6

CAZOLETA HORIZONTAL

Código	Rejilla	Ø Salida	H1	H2	A	B	Ud. Embalaje
CZL075H	150 x 150	Ø 75	65	110	140	220	6
CZL090H	200 x 200	Ø 90	80	135	180	290	6
CZL110H	250 x 250	Ø 110	80	145	220	350	6

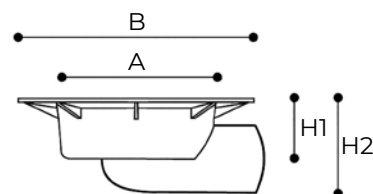

CAZOLETA, SUMIDERO SIFÓNICO DE PVC Y PARAHOJAS



Código	Tamaño	Descripción	Ud. Embalaje
CZPH090V	200 x 200 Vertical	Cazoleta con sumidero y parahojas de 200x200. Salida vertical Ø 90 mm y altura 180 mm	6
CZPH110V	250 x 250 Vertical	Cazoleta con sumidero y parahojas de 250x250. Salida vertical Ø 90 - 110 mm y altura 240 mm	6
CZPH090H	200 x 200 Horizontal	Cazoleta con sumidero y parahojas de 200x200. Salida horizontal Ø 90 mm y altura 180 mm	6
CZPH110H	250 x 250 Horizontal	Cazoleta con sumidero y parahojas de 250x250. Salida horizontal Ø 110 mm y altura 240 mm	6

SUMIDERO SIFÓNICO DE PVC Y PARAHOJAS



Código	Tamaño	Descripción	Ud. Embalaje
SSV20PH	200 x 200	Sumidero de 200 x 200 con parahojas salida Ø 90 mm y altura 85 mm	6
SSV25PH	250 x 250	Sumidero de 250 x 250 con parahojas salida Ø 90 - 110 mm y altura 85 mm	6

ACCESORIOS DE IMPERMEABILIZACIÓN

CLAVO TACO DE EXPANSIÓN PARA PANEL AISLANTE

Fijación de aislamiento de polipropileno $\varnothing 10$ con clavo de plástico reforzado. Específico para paneles aislantes rígidos. Para materiales macizos sugerimos hacer agujeros $\varnothing 12$ mm.

NOVEDAD

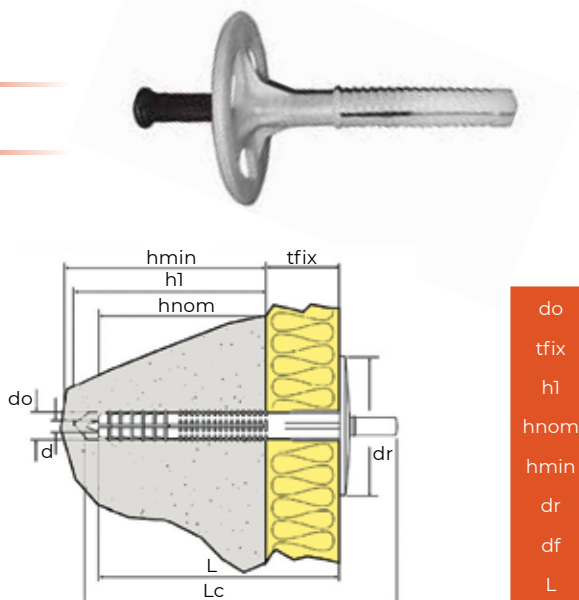

do	Diámetro
tfix	Espesor a fijar
h1	Mínima profundidad del taladro
hnom	Profundidad de empotramiento
hmin	Mínimo espesor del material base
dr	Diámetro de arandela
df	Diámetro de agujero en pieza a fijar
L	Longitud

Código	Ud. Emb.	do x L (mm)	Tfix Min. (mm)	Tfix Max (mm)	H1 (mm)	Hnom (mm)	Hmin (mm)	Dr (mm)
CTE070	250	10 x 70	20	45	40	30	80	50
CTE090	250	10 x 90	40	65	40	30	80	50
CTE110	250	10 x 110	70	95	40	30	80	50
CTE130	250	10 x 130	90	110	40	30	80	50
CTE150	250	10 x 150	115	130	40	30	80	50
CTE180	250	10 x 180	130	155	40	30	80	50

FIJACIONES PARA LÁMINAS IMPERMEABILIZANTES

Perfil y pletina de acero galvanizado y plastificado colaminado con PVC, para fijación de láminas de EPDM, PVC y asfalto.

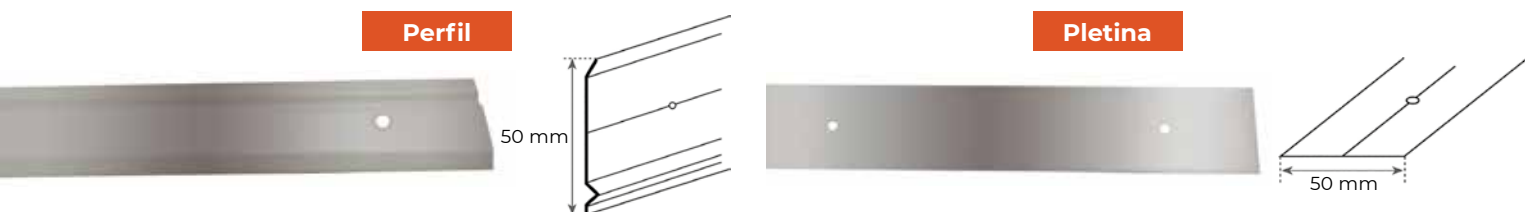

Código	Descripción	Ud. Embalaje
PFAZ12	Perfil galvanizado de 2000 x 50 x 1,2 mm, con perforaciones $\varnothing 6$ mm. Una perforación cada 200 mm	100
PFPVC12	Perfil plastificado PVC de 2000 x 50 x 1,2 mm con perforaciones $\varnothing 6$ mm. Una perforación cada 200 mm	100
PLAZ12	Pletina galvanizada de 2000 x 50 x 1,2 mm, con perforaciones $\varnothing 6$ mm. Una perforación cada 200 mm	100
PLPVC12	Pletina plastificada PVC de 2000 x 50 x 1,2 mm con perforaciones $\varnothing 6$ mm. Una perforación cada 200 mm	100